



**ENDÜSTRİ**  
AYDINLATMA ÜRÜNLERİ



AYDINLATMA

## **BAŐLİK**

### **Yayımcı**

EAE Aydınlatma

### **Yaratım ve Tasarım:**

EAE Aydınlatma

### **Resim:**

EAE Aydınlatma

### **Sorumluluk Reddi:**

Bu katalogda atıfta bulunulan referansların içerięi konusunda hiçbir sorumluluk kabul etmiyoruz. Referansların içerięi tamamen yayımcılarının sorumluluęundadır.

### **Telif Hakkı:**

Bu kataloęun tüm içerięi telif hakkı ile korunmaktadır. EAE Aydınlatma A.Ő.'nin açık yazılı izni olmadan depolanamaz, çoęaltılamaz, dağıtılamaz veya başka herhangi bir őekilde kullanılamaz.

# İçindekiler

SROUND INDUSTRY	8
SROUND	10
REVOLED-X	12
REVERO	14
RERERO NG	16
RERERO SQ	18
HBL	20
HBC	22
HBC - EXPROOF	24
EX LINE MINI	26
EX FOR MINI	28
CUSHIDO	30
PROLIT - EXPROOF	32
PROLIT KOMPAKT	34
PROLIT	36
PROLIT PLUS	38
PROLIT PLUS APRON	40
PROLIT EFFECT	42
MFL	44
VALERIA	46

RA 1-2-3	48
HORUS 1-2	50
OSIRIS	52
ARKTOS NG	54
INFINOO	56
M-LINE	60
GALIS MEGA	62
GALIS	64
YPB BATWING	66
LINA NG	68
TORNADO	70
COZAR	72
YPL NG	74
GPRONA	76
SPRONA	78
SPRONA PLUS	80
AGILITY	82
ALFA	84
KANOLED	86

# EAE Aydınlatma

EAE Aydınlatma olarak, 1983 yılında başlayan yenilik ve tutku dolu serüvenimiz hız kesmeden devam ediyor. Geride bıraktığımız 40 yılın getirisi olan bilgi birikimi ve tecrübe sayesinde âdeta sektörün standartlarını belirleyen yüksek tavan aydınlatma ürünlerimizle kendimizden söz ettirirken, aynı kalite anlayışını dekoratif ürünlerimizde ise estetik ve fonksiyonellikle birleştirerek sunuyoruz. Süregelen deneyimimiz boyunca attığımız her adımda inovasyona odaklanarak modern üretim tesislerimizde özverili bir şekilde çalışıyoruz. AR-GE departmanımız tarafından tasarlanıp geliştirilen ürünlerimiz, büyük bir titizlikle laboratuvarlarımızda test edilerek, EAE Aydınlatma ile özdeşleşmiş olan yüksek kalite ve dayanıklılık standartlarını korumamıza yardımcı oluyor. Bu standartlar sayesinde ürettiğimiz uzun ömürlü ürünlerimiz; daha az atık, daha az enerji sarfiyatı ve daha az doğal kaynak kullanımıyla birlikte, geleceğe bırakacağımız daha yeşil bir dünya hedefimize bizi bir adım daha yaklaştırıyor.



**1983**  
Kuruluş

**%90** Yurtiçi Onaylı  
Tedarikçi Oranı, 2022



**33,6 Milyon TL**  
AR-GE Yatırımları



**362**  
Çalışan Sayısı



**4,4 Milyon ABD Doları**  
Altyapı Yatırımları



**4344**  
(Kişi x Saat) İş Sağlığı ve  
Güvenliği Eğitimi



**2.**  
Türkiye İhracatçılar Meclis  
(TİM)



**15966**  
(Kişi x Saat) Eğitim, Toplam



**2860 GWh**  
Yıllık Yenilenebilir Enerji (GES)  
Kapasitesi



**40**  
İhracat Yapılan Ülke  
Sayısı



**911 Ton**  
Geri Dönüştürülen Atık  
Miktarı



**%91,33**  
Müşteri Memnuniyeti Oranı



**2,3 Milyon ABD Doları**  
Yenilenebilir Enerji (GES)  
Yatırımları



**1629 m3**  
Yağmur Suyu Depolama  
Kapasitesi



**1046**  
(Kişi x Saat) Sürdürülebilirlik  
ve Karbonsuzlaşma Eğitimi



## Uygulama Alanları



### Ağır Sanayi Petrol & Gaz

- Petrokimya
- Rafineri
- Offshore
- Madencilik



### Otomotiv Demir & Çelik-Cam

- Otomotiv ve Yan Sanayi
- Cam Fabrikası
- Demir & Çelik Fabrikaları
- Haddehaneler



### Enerji Santralleri

- Nükleer Enerji Santralleri
- Buhar Santralleri
- Kombine Çevrim Santralleri
- HES, JES, GES



### Fabrikalar Üretim Tesisleri

- Tekstil
- Makine-Metal
- Plastik
- Gıda A.Ş.
- İlaç



### Demiryolları ve Tüneller

- Metro Tünelleri
- Kara Yolu Tünelleri
- Demir Yolu Tünelleri
- Tren İstasyonları



### Veri Merkezleri

- GSM & Telekom Şirketleri
- Ortak Barındırma Hizmet Sağlayıcıları
- Finansal Kurumlar
- Kamu Veri Merkezleri
- Uç Veri (Edge) Merkezleri
- Bilgisayar Odaları



### Hastaneler

- Sağlık Kuruluşları
- Klinikler
- Laboratuvarlar



### Kompleks Binalar ve Kuleler

- Kule ve Gökdelenler
- Alışveriş Merkezleri
- Ofis Binaları
- Oteller
- Rezidanslar
- Hükümet Binaları



### Spor Kompleksleri

- Stadyumlar
- Kapalı Spor Kompleksleri
- Olimpiyat Kompleksleri



### Havaalanları

- Terminal Binaları
- Otopark
- Hangarlar
- Hizmet Binaları

## Sertifika

- ISO 9001: 2015
- ISO 10002: 2018
- ISO 14001: 2015
- ISO 27001: 2013
- ISO 45001: 2018
- ISO 50001: 2018
- ISO 14064-1:2018

- TURKISH ACCREDITATION AGENCY
- DEKRA
- DIALUX PARTNER
- UL SOLUTIONS (DEMKO)

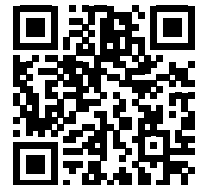

TARAMA QR  
SERTİFİKALAR İÇİN

# SROUND INDUSTRY

-35°C +80°C



- Endüstri Alanları
- Vinçler

## Endüstriyel ortamlar için +80°C'ye kadar yüksek direnç

- ✓ -35°C'den +80°C'ye kadar ortam çalışma sıcaklığı
- ✓ IP65 - IP66 koruma & IK09 darbe dayanım sınıfı / Temperli cam
- ✓ Zorlu endüstriyel ortamlarda maksimum performans
- ✓ 10 m kablo uzunluğuna kadar harici kutu seçeneği
- ✓ Farklı montaj ve sabitleme seçenekleri
- ✓ Eşsiz tasarım



### SROUND Industry

52 W – 405 W  
8629 lm - 52400 lm

OPTİK  
Arena / Lowbay

### SROUND Mini (TK)

33 W – 88 W  
4605 lm - 11367 lm

OPTİK  
75° / 103°

### SROUND İkili

104 W - 810 W  
17258 lm - 104800 lm

OPTİK  
Arena / Lowbay



## Teknik Çizim | Industry

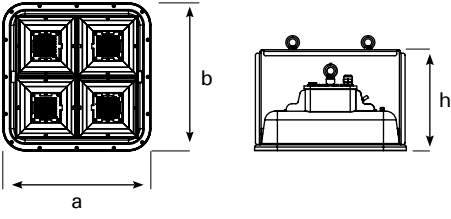

## Teknik Çizim | İkili

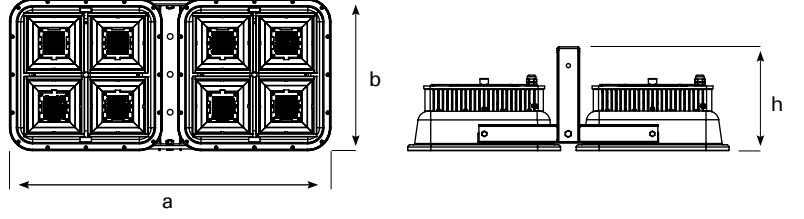

## Teknik Çizim | Industry Ext.

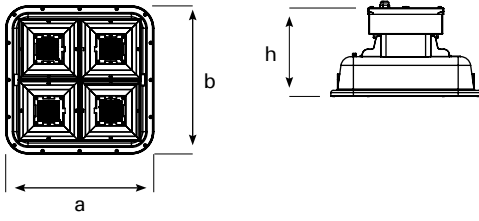

## Teknik Çizim | Mini (TK)

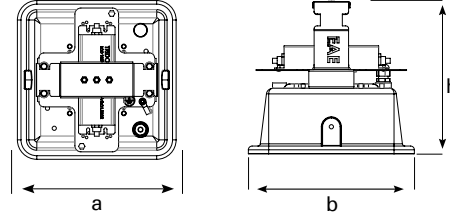

### Ölçüler (mm)

	a	b	h
Industry	401	401	269
İkili	842	401	276
Industry Ext.	400	400	269
Mini (TK)	265	265	244

### Dış Kutu Hariç Ağırlık (kg)

Industry	8,3
İkili	19,1
Mini (TK)	3,5

## Harici Sürücü Modülü

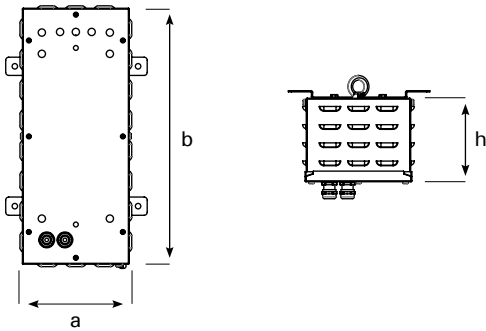

### Ölçüler (mm)

	a	b	h
Harici Sürücü Modülü	184	429	138

## Tekli U Tipi Askı Takımı

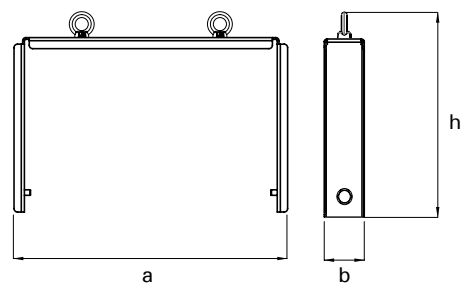

### Ölçüler (mm)

	a	b	h
Tekli U Tipi Askı Takımı	396	59	290

# SROUND

-25°C +60°C



- Demir-Çelik ve Ağır Sanayi
- Havalimanı
- Otomotiv Endüstrisi
- Lojistik
- Cam ve Seramik
- Makine ve Elektronik
- Kimyasal ve Plastik
- Ahşap ve Kâğıt
- Spor Salonları

## Gözü yükseklerde olanlara

- ✓ Yüksek performanslı LED armatür
- ✓ IP65 - IP66 koruma & IK09 darbe dayanım sınıfı
- ✓ -25°C'den +60°C'ye kadar ortam çalışma sıcaklığı
- ✓ Farklı montaj türlerine olanak tanıyan çeşitli askı takımları
- ✓ 3 saate kadar acil kit seçeneği / Akıllı aydınlatma için farklı tip sürücü seçenekleri



### SROUND IP65 & IP66

52 W - 226 W  
8629 lm - 32400 lm

#### OPTİK

Arena / Lowbay /  
Extra-Lowbay

### SROUND Mini

33 W - 88 W  
4605 lm - 11367 lm

#### OPTİK

75° / 103°

### SROUND Crane

68 W - 173 W  
10500 lm - 25600 lm

#### OPTİK

Arena / Lowbay /  
Extra-Lowbay

### SROUND Red

140 W  
8666 lm

#### OPTİK

Arena

### SROUND Chemical

69 W - 137 W  
12171 lm - 21506 lm

#### OPTİK

Arena / Lowbay /  
Extra-Lowbay

### Teknik Çizim | IP65 & IP66 koruma

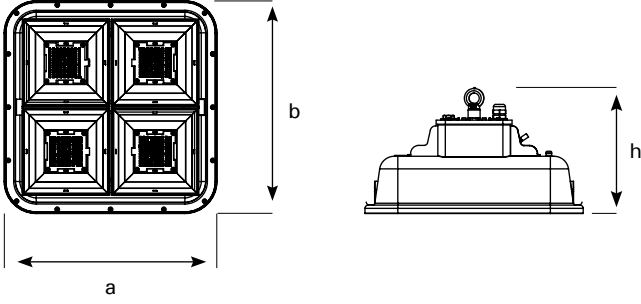

### Teknik Çizim | Mini (TK)

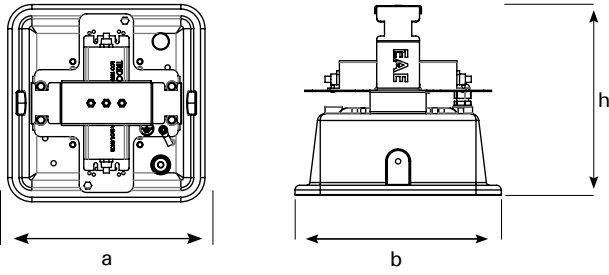

### Ölçüler (mm)

	a	b	h
IP65 & IP66 koruma	400	400	231
Mini	265	265	244
Crane	400	400	231
Red	400	400	231
Chemical	400	400	231

### Ağırlık (kg)

IP65 & IP66 koruma	7,2
Mini	3,5
Crane	-
Red	7,7
Chemical	7,2

# REVOLED-X

-30°C +70°C



- Demir-Çelik ve Ağır Sanayi
- Havalimanı
- Otomotiv Endüstrisi
- Lojistik
- Cam ve Seramik
- Makine ve Elektronik
- Kimyasal ve Plastik
- Ahşap ve Kâğıt
- Spor Salonları



## Performansı en üst düzeyde deneyimleyin

- ✓ -30°C'den +70°C'ye kadar ortam çalışma sıcaklığı
- ✓ IP65 - IP66 koruma & IK07 - IK08 - IK09 darbe dayanım sınıfı
- ✓ Montaj çeşitleri: Tava / Busbar / Dereceli Duvar / Sismik
- ✓ 1 - 3 Saat ACK / DALI - RF kablosuz kontrol seçenekleri



### REVOLED-X

28 W - 128 W  
4163 lm - 21078 lm

#### OPTİK

30°x90° / 30° / 60° / 90° /  
AS / DA / 25x105°



### REVOLED-X HE

26 W - 117 W  
4080 lm - 20566 lm

#### OPTİK

30°x90° / 30° / 60° / 90° /  
AS / DA / 25x105°



### REVOLED-X EVO

67 W - 338 W  
9008 lm - 44226 lm

#### OPTİK

30°x90° / 30° / 60° / 90° / AS  
/ DA / 25x105°

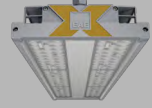

### REVOLED-X EVO IP65

67 W - 338 W  
9008 lm - 44226 lm

#### OPTİK

30°x90° / 30° / 60° / 90° /  
AS / DA / 25x105°



### REVOLED-X HOT / HOT PLUS

28 W - 128 W  
4294 lm - 21078 lm

#### OPTİK

30°x90° / 30° / 60° / 90° /  
AS / DA / 25x105°

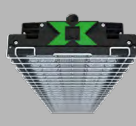

### REVOLED-X SPORT

28 W - 337 W  
4294 lm - 42102 lm

#### OPTİK

30°x90° / 30° / 60° / 90° /  
AS / DA / 25x105°



### REVOLED-X STERIL

28 W - 128 W  
4294 lm - 21078 lm

#### OPTİK

30°x90° / 30° / 60° / 90° /  
AS / DA / 25x105°



### REVOLED-X FOOD / FOOD COLD

28 W - 128 W  
4294 lm - 21078 lm

#### OPTİK

30°x90° / 30° / 60° / 90° /  
AS / DA / 25x105°

## Teknik Çizim

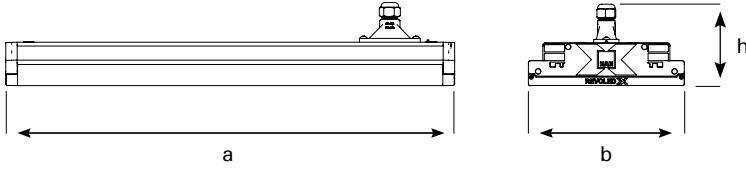

## Ölçüler (mm)

	a	b	h
Standart	423	209	109
Dali CG (Çift Giriş)	493	209	109
1-3 saat ACK*	950	209	109
Kutulu 1-3 saat ACK*	603	209	135

## Ağırlık (kg)

Standart	3,24
Dali CG (Çift Giriş)	3,77
1-3 saat ACK*	7,26
Kutulu 1-3 saat ACK*	7

## Busbar Askı Takımı (SL / DL)

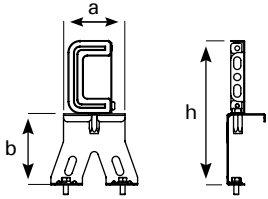

## Tava Askı Takımı

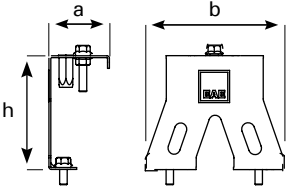

## Dereceli Askı Takımı

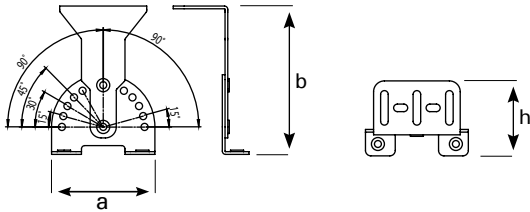

## Sismik Askı Takımı

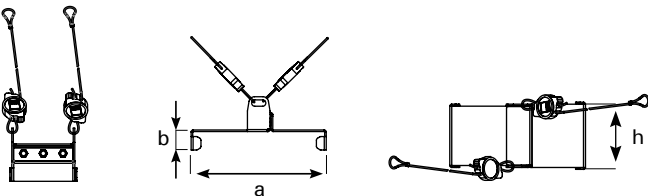

## Ölçüler (mm)

	a	b	h
Busbar Askı Takımı (SL/DL)	78	90	182,5
Busbar İkili Askı Takımı	182,6	-	90
Tava Askı Takımı	48	110	90
İkili Tava Askı Takımı	358,60	-	90

## Busbar İkili Askı Takımı (SL / DL)

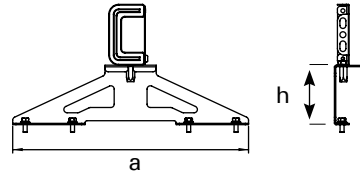

## İkili Tava Askı Takımı

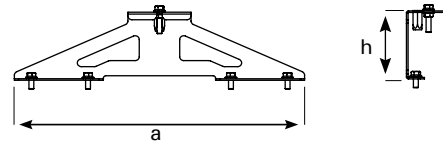

## 90° Busbar Askı Takımı (SL / DL)

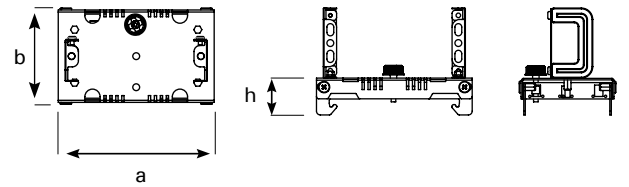

## 90° Tava Askı Takımı

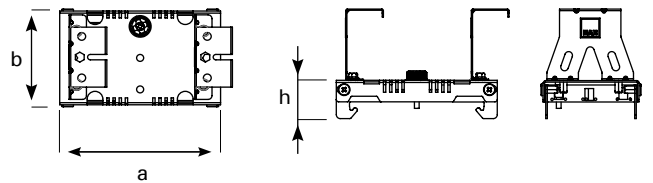

## Ölçüler (mm)

	a	b	h
Dereceli Askı Takımı	95	135	69,5
90° Busbar Askı Takımı (SL/DL)	205	122	48
Sismik Askı Takımı	171,88	25,30	75
90° Tava Askı Takımı	205	122	48

# REVERO

-20°C +40°C



- Endüstriyel Tesisler
- Havacılık ve Havaalanları
- Spor Salonları
- Lojistik

## Aydınlatmada maksimum konfor

- ✓ Yüksek tavan LED armatürü
- ✓ IP65 koruma & IK05 darbe dayanım sınıfı / Alüminyum enjeksiyon gövde
- ✓ Optik Seçenekleri: Şeffaf difüzör / Opal difüzör / Mikroprizmatik difüzör
- ✓ -20°C'den +40°C'ye kadar ortam çalışma sıcaklığı
- ✓ 3 saate kadar acil kit seçeneği / Akıllı aydınlatma için farklı tip sürücü seçenekleri



### REVERO

70 W - 149 W  
9294 lm - 22400 lm

Mikroprizmatik Difüzör /  
Opal Difüzör /  
Şeffaf Difüzör

## Teknik Çizim

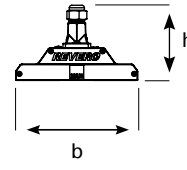
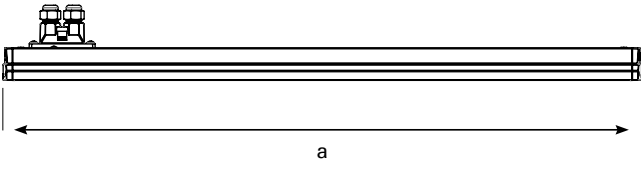

## Ölçüler (mm)

	a	b	h
Standart	773	148	92

## Ağırlık (kg)

Standart	1,9
----------	-----

## Busbar Askı Takımı ( SL / DL )

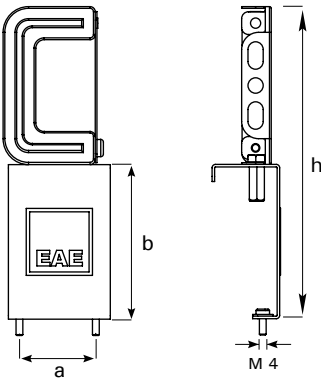

## Tava Askı Takımı

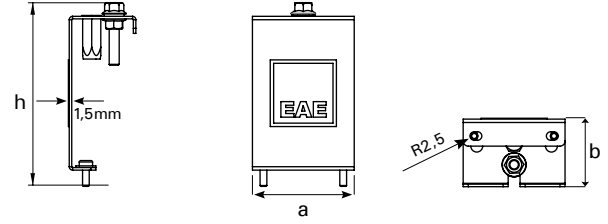

## Dereceli Askı Takımı

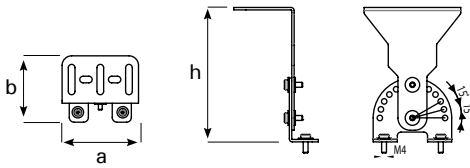

## Ölçüler (mm)

	a	b	h
Busbar Askı Takımı (SL/DL)	45	90	182
Tava Askı Takımı	60	40	107
Dereceli Askı Takımı	47	70	109,5

# RERERO NG

-20°C +35°C



- Kapalı Depolar
- Fabrika ve Atölyeler
- Spor Salonları
- Servis İstasyonları
- Ticari Yapılar

## Optimum aydınlatma kalitesi, minimum maliyet

- ✓ IP64 koruma & IK08 darbe dayanım sınıfı / Hafif gövde tasarımı
- ✓ İşletmeler için yüksek enerji tasarrufu
- ✓ Gelişmiş tasarımı sayesinde kolay bakım
- ✓ -20°C'den +35°C'ye kadar ortam çalışma sıcaklığı
- ✓ Busbar veya kablo kanalına monte edilebilir

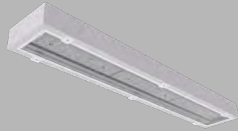

### RERERO NG

50 W – 115 W  
6579 lm – 16321 lm

Temperli Cam



### RERERO NG

70 W – 150 W  
8600 lm – 18000 lm

Temperli Kumlu Cam



## Teknik Çizim

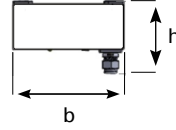
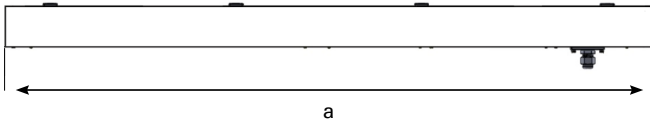

## Ölçüler (mm)

	a	b	h
Standart	770	154	96,8

## Ağırlık (kg)

Standart	6,5
----------	-----

## Busbar Askı Takımı ( SL / DL )

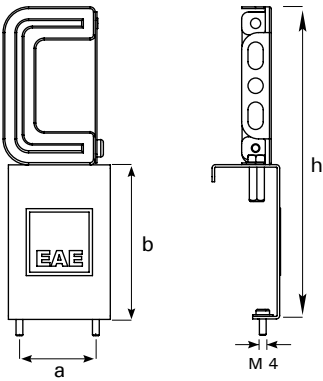

## Tava Askı Takımı

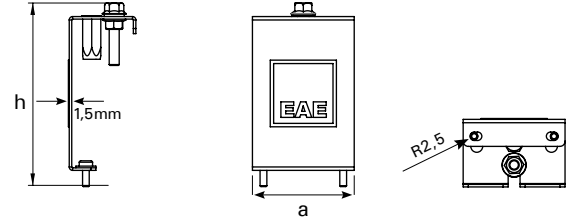

## Dereceli Askı Takımı

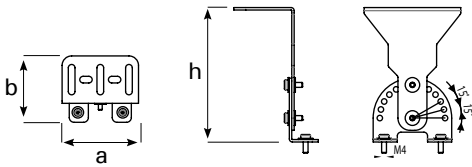

## Ölçüler (mm)

	a	b	h
Busbar Askı Takımı (SL/DL)	45	90	182
Tava Askı Takımı	60	40	107
Dereceli Askı Takımı	47	70	109,5

# RERERO SQ

-20°C +50°C



- Lojistik
- Otomotiv
- Makine ve Elektronik
- Havaalanı
- Cam ve Seramik
- Kimyasal ve Plastik
- Ahşap ve Seramik

## Düşük enerji tüketimi yüksek performans

- ✓ Uygun maliyetli yüksek tavan armatürü
- ✓ Boyalı sac gövde
- ✓ IP64 koruma & IK07 darbe dayanım sınıfı
- ✓ -20°C'den +50°C'ye kadar ortam çalışma sıcaklığı
- ✓ 3 saate kadar acil kit seçeneği / DALI kontrol seçeneği

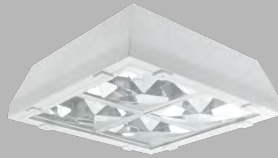

### RERERO SQ

70 W – 133 W  
11598 lm - 19938 lm

OPTİK  
Cam

## Teknik Çizim

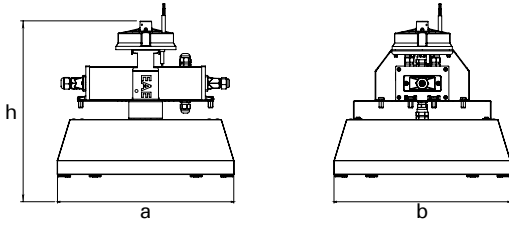

## Ölçüler (mm)

	a x b	h
Standart	378,5	244

## Busbar Askı Takımı (SL / DL)

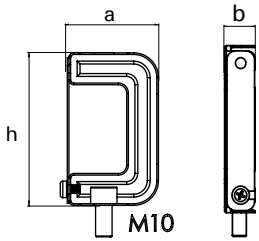

## Mapa Askı Takımı

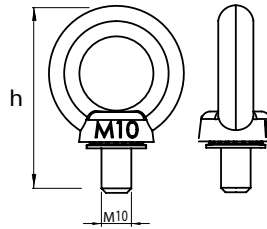

## Kablo Tavası Askı Takımı

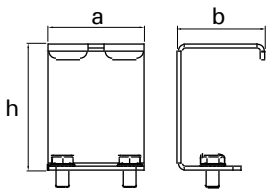

## Ölçüler (mm)

	a	b	h
Busbar Askı Takımı (SL / DL)	55	17	92
Mapa Askı Takımı	-	-	62,5
Kablo Tavası Askı Takımı	53	50	102,5

# HBL

-30°C +65°C



- Endüstriyel Tesisler
- Hangarlar ve Havalimanları
- Lojistik
- Spor Salonları

## Endüstriyel tesisler için geliştirilmiş optimum aydınlatma performansı

- ✓ Optimum çözüm sağlayan LED armatür
- ✓ IP65 - IP66 koruma & IK10 darbe dayanım sınıfı / Alüminyum enjeksiyon gövde ve serigrafi cam
- ✓ -30°C'den +65°C'ye kadar ortam çalışma sıcaklığı
- ✓ Akıllı aydınlatma kontrolü sağlayan sensör seçeneği
- ✓ İç ve dış mekânlara uygun armatür
- ✓ 3 saate kadar acil kit seçeneği / Akıllı aydınlatma için farklı tip sürücü seçenekleri



### HBL IP65 Lens + Cam

88 W – 182 W  
11200 lm – 27418 lm

OPTİK  
55° / 90°



### HBL IP66 Koruma Lens

65 W – 261 W  
9295 lm – 41314 lm

OPTİK  
55° / 90°



### HBL IP66 Koruma Lens + Cam

65 W – 253 W  
8700 lm – 36400 lm

OPTİK  
55° / 90°



### HBL PRJ TK

167 W – 253 W  
22596 lm – 36400 lm

OPTİK  
55° / 90°

IP65 Lens

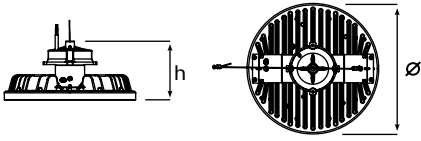

IP66 Koruma Lens + Cam

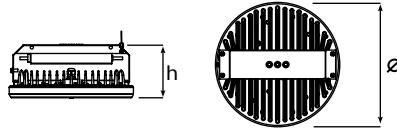

IP66 Lens

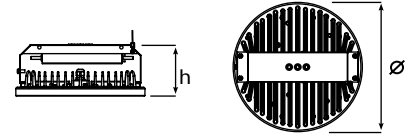

Ölçüler (mm)

	Ø x h
IP65 Lens + Cam	315 x 152
IP66 Koruma Lens + Cam	315 x 135
IP66 Koruma Lens	315 x 127

Ağırlık (kg)

IP65 Lens + Cam	4,6
IP66 Koruma Lens + Cam	5,5
IP66 Koruma Lens	6,5

Ölçüler (mm)

	a	b	h
Busbar Askı Takımı (SL/DL)	55	17	92
Tekli Mapa Askı Takımı	-	-	50,5
Tava Askı Takımı	60	54,5	80
Tava ACK Askı Takımı	69	54,5	103
İkili Mapa Askı Takımı	-	-	50,5
İkili Mapa ACK Kit Askı Takımı	78	45	59,5
HBL IP65 Mapa Askı Takımı	-	-	62,5
HBL IP65 Kablo Tavası Askı Takımı	-	-	103
HBL IP65 Busbar Askı Takımı (SL/DL)	-	-	92

Busbar Askı Takımı ( SL / DL )

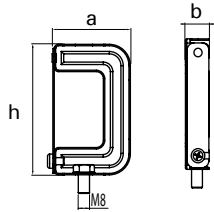

Tekli Mapa Askı Takımı

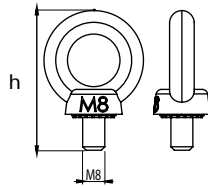

HBL IP65 Mapa Askı Takımı

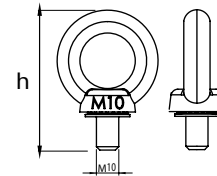

Tava Askı Takımı

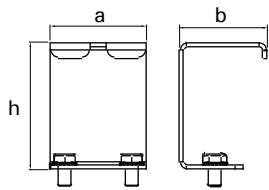

Tava ACK Askı Takımı

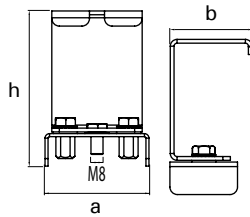

HBL IP65 Busbar Askı Takımı ( SL / DL )

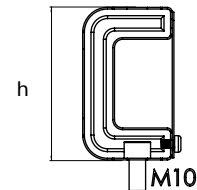

İkili Mapa Askı Takımı

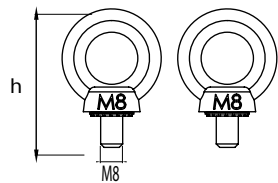

İkili Mapa ACK Kit Askı Takımı

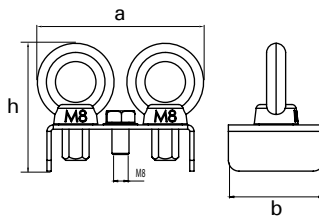

HBL IP65 Kablo Tavası Askı Takımı

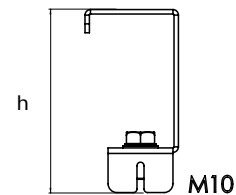

Terminal Kutulu Opsiyonel Versiyon

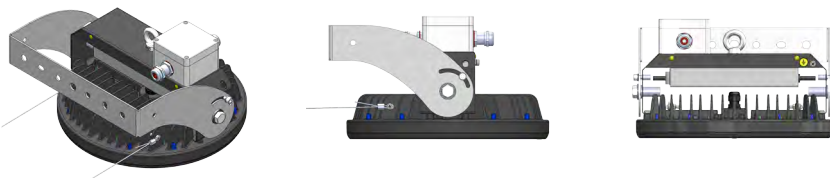

# HBC

-20°C +60°C



- Endüstri Alanları
- Spor Salonları
- Alışveriş Merkezleri

## Fonksiyonel ve verimli aydınlatma

- ✓ Yüksek performanslı LED armatür
- ✓ IP66 koruma & IK05 - IK10 darbe dayanım sınıfı
- ✓ -20°C'den +60°C'ye kadar ortam çalışma sıcaklığı
- ✓ 400W Metal Halide armatür performansına denktir
- ✓ Cam kapak seçeneği
- ✓ Çeşitli optik seçenekleri
- ✓ Kullanım alanına göre değişken askı seti seçenekleri
- ✓ Akıllı aydınlatma kontrolü sağlayan sensör seçeneği
- ✓ 3 saate kadar acil kit seçeneği / Akıllı aydınlatma için farklı tip sürücü seçenekleri

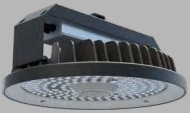

### HBC Lens

79 W – 220 W  
9860 lm – 26980 lm

OPTİK  
60°/ 90°

### HBC Lens + Cam

75 W – 220 W  
8957 lm – 24600 lm

OPTİK  
60°/ 90°

### HBC Lens + ACK Kit

79 W – 206 W  
9860 lm – 25800 lm

OPTİK  
60°/ 90°

### HBC Lens + Cam + ACK Kit

79 W – 155 W  
8957 lm – 18616 lm

OPTİK  
60°/ 90°

### Teknik Çizim | Lens

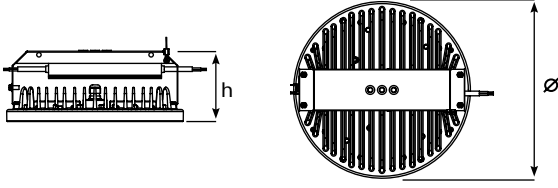

### Teknik Çizim | Lens + ACK Modül

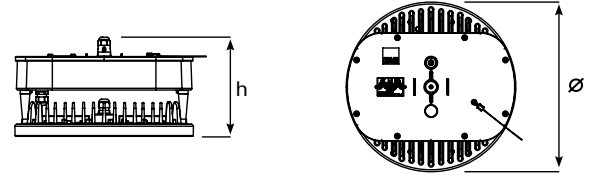

### Ölçüler (mm)

	Ø x h
Lens	315 x 127
Lens + ACK Modül	315 x 162

### Ağırlık (kg)

Lens	4
Lens + ACK Modül	6

### Busbar Askı Takımı ( SL / DL )

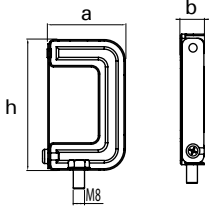

### Tekli Mapa Askı Takımı

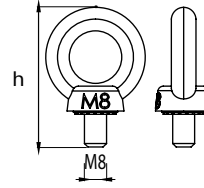

### Tava Askı Takımı

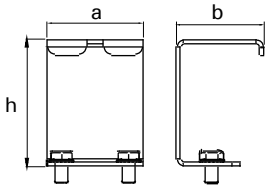

### Tava ACK Armatür Askı Takımı

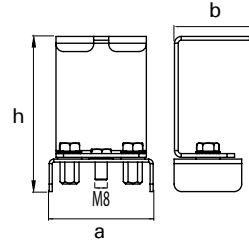

### İkili Mapa Askı Takımı

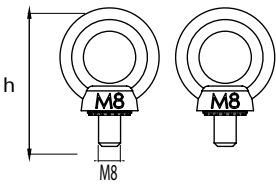

### İkili Mapa ACK Armatür Askı Takımı

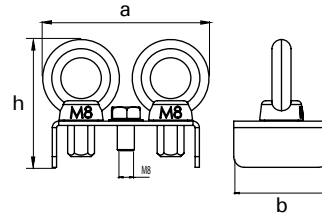

### Ölçüler (mm)

	a	b	h
Busbar Askı Takımı (SL/DL)	55	17	92
Tekli Mapa Askı Takımı	-	-	50,5
Tava Askı Takımı	60	54,5	80
Tava ACK Armatür Askı Takımı	69	54,5	103
İkili Mapa Askı Takımı	-	-	50,5
İkili Mapa ACK Armatür Askı Takımı	78	45	59,5

# HBC

## EXPROOF ZONE-1 / ZONE-2

-30°C +55°C



- Petrol Rafinerileri
- Boya ve Melamin Üretim Tesisleri
- Petrokimya ve Kimya
- Benzin İstasyonları

## Ex-Proof alanların güvenilir seçeneği

- ✓ Tehlikeli madde içeren çevre koşullarında güvenilir kullanım sağlayan sızdırmaz gövde tasarımı
- ✓ IP66 koruma & IK10 darbe dayanım sınıfı / Temperli serigrafi cam
- ✓ -30°C'den +55°C'ye kadar ortam çalışma sıcaklığı
- ✓ Patlayıcı ve yanıcı maddelerin üretildiği tesislerde bölge sınıflandırması: Bölge 1 / 21 - 2 / 22 Grup / Kategori: II / 2.1 2GD Koruma sınıfı: db / mb / eb / tb Zone 2.21 3G / 2D koruma sınıfı nR / tb
- ✓ Yüksek verimlilik, düşük güç tüketimi
- ✓ 3 saate kadar acil kit seçeneği / Akıllı aydınlatma için farklı tip sürücü seçenekleri



### HBC EXPROOF-ZONE 1.21

70 W – 130 W  
8400 lm – 15000 lm

OPTİK  
110°



### HBC EXPROOF-ZONE 2.21

75 W – 197 W  
8000 lm – 20100 lm

OPTİK  
50° / 80°



## Ölçüler (mm)

	Ø x h
Zone 1	315 x 251
Zone 2	315 x 201

## Ağırlık (kg)

Zone 1	10,1
Zone 2	6,8



## Teknik Çizim | Zone 1

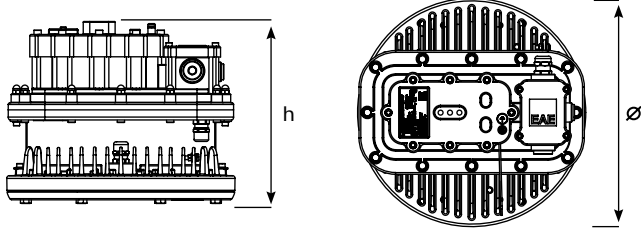

## Teknik Çizim | Zone 2

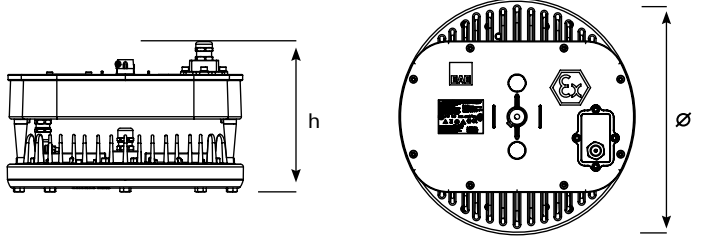

## Tava Tekli Askı Takımı Ex Zone 1

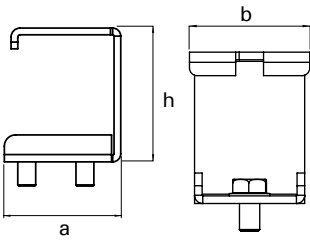

## Dereceli Askı Takımı Sıva Üstü

Ex Zone 1

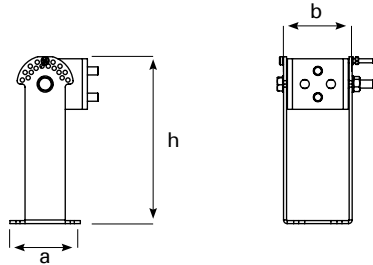

## Mapa Askı Takımı Ex Zone 1

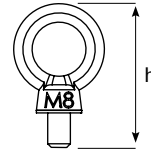

## Boru Montaj Askı Takımı

Ex Zone 1

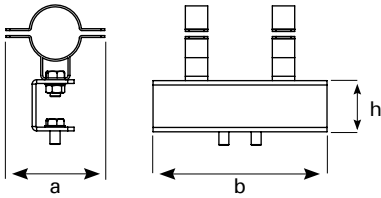

## Sıva Üstü Askı Takımı Ex Zone 1

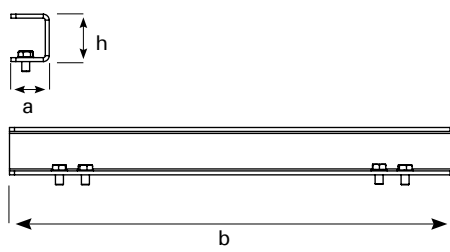

## Sıva Altı Duvar Askı Takımı

Ex Zone 1

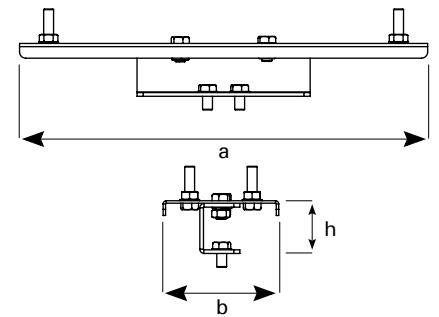

## Tava İkili Askı Takımı Ex Zone 2

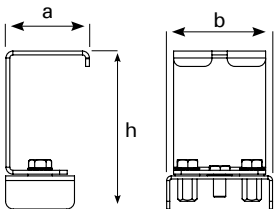

## Busbar Askı Takımı (SL/DL)

Ex Zone 2

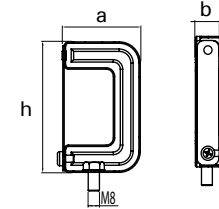

## İkili Mapa Askı Takımı

Ex Zone 2

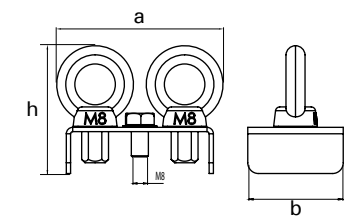

## Ölçüler (mm)

	a	b	h
Tekli Tava Askı Takımı Ex Zone 1	52	47,5	60
Dereceli Askı Takımı Sıva Üstü Ex Zone 1	70,1	68,2	162
Mapa Askı Takımı Ex Zone 1	-	-	50,5
Boru Montaj Askı Takımı Ex Zone 1	77,8	140	41
Sıva Üstü Montaj Askı Takımı Ex Zone 1	39,3	446	48

	a	b	h
Duvar Askı Takımı Ex Zone 1	330	94	43
Tava İkili Askı Takımı Ex Zone 2	54,5	69	103
Busbar Askı Takımı (SL/DL) Ex Zone 2	55	17	92
İkili Mapa Askı Takımı Ex Zone 2	78	45	59,5

# EX-LINE

## MINI ZONE-1

-40°C +45°C

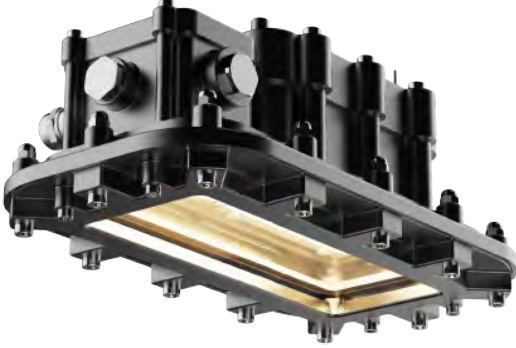

- Petrol Rafinerileri
- Boya ve Melamin Üretim Tesisleri
- Petrokimya ve Kimya
- Benzin İstasyonları

## Sağlam gövdeli, yüksek kaliteli Ex-Proof armatür

- ✓ Patlayıcı ve yanıcı maddelerin üretildiği tesislerde bölge sınıflandırması: Bölge 1 / 21 - 2 / 22 Grup / Kategori:II / 2GD Koruma sınıfı: db / tb / eb
- ✓ IP66 koruma & IK10 darbe dayanım sınıfı / Alüminyum enjeksiyon gövde
- ✓ -40°C'den +45°C'ye kadar ortam çalışma sıcaklığı
- ✓ DALI kontrol seçeneği

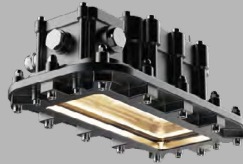

### EX-LINE MINI

20 W – 57 W  
2695 lm – 7089 lm

OPTİK  
Geniş Açılı

## Teknik Çizim

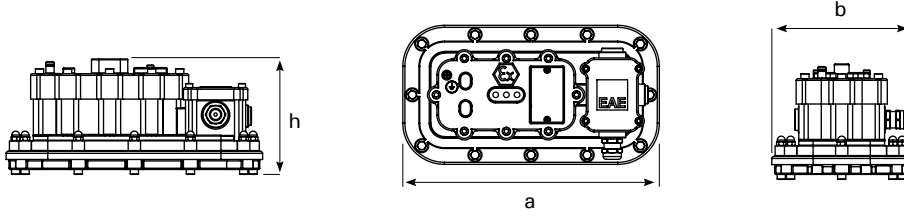

### Ölçüler (mm)

	a	b	h
Mini Zone 1	311	171	141

### Ağırlık (kg)

Mini Zone 1	5,2
-------------	-----

### Sıva Üstü Montaj Askı Takımı

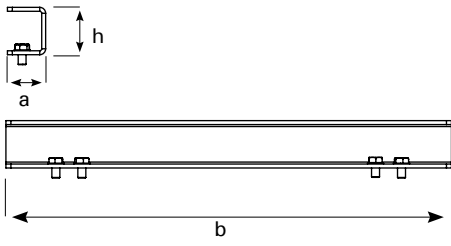

### Boru Montaj Askı Takımı

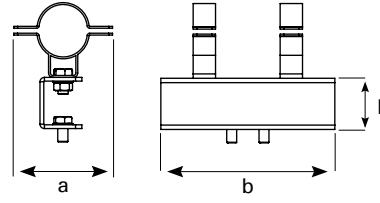

### Dereceli Askı Takımı Sıva Üstü

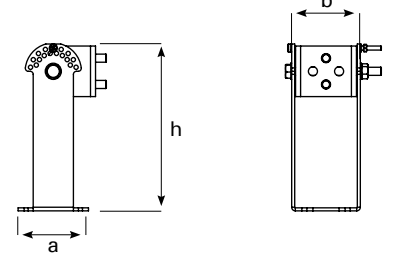

### İkili Tava Askı Takımı

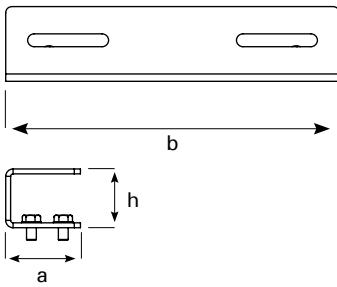

### Tava Askı Takımı

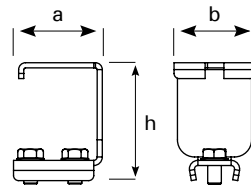

### Mapa Askı Takımı

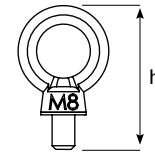

### Ölçüler (mm)

	a	b	h
Sıva Üstü Montaj Askı Takımı	39,3	446	48
Boru Montaj Askı Takımı	77,8	140	41
Dereceli Askı Takımı Sıva Üstü	70,1	68,2	162
İkili Tava Askı Takımı	61	270	48
Tava Askı Takımı	52	47	69
Mapa Askı Takımı	-	-	50,5

# EX FOR MINI



- Petrol Rafinerileri
- Boya ve Melamin Üretim Tesisleri
- Petrokimya ve Kimya
- Benzin İstasyonları

-40°C +45°C



## Minimalist tasarım, yüksek verimlilik

- ✓ Patlayıcı ve yanıcı maddelerin üretildiği tesislerde bölge sınıflandırması: Bölge 1 / 21 - 2 / 22 Grup / Kategori:II / 2GD Koruma sınıfı: db / tb
- ✓ IP66 koruma & IK10 darbe dayanım sınıfı / Alüminyum enjeksiyon gövde
- ✓ -40°C'den +45°C'ye kadar ortam çalışma sıcaklığı
- ✓ DALI kontrol seçeneği



### EX-FOR MINI

20 W – 51 W  
2300 lm – 5540 lm

**OPTİK**  
Geniş Açılı

## Teknik Çizim

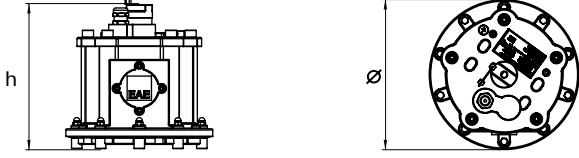

### Ölçüler (mm)

	Ø x h
Ex-For Mini	225 x 221

### Ağırlık (kg)

Ex-For Mini	5,5
-------------	-----

### Tekli Tava Askı Takımı

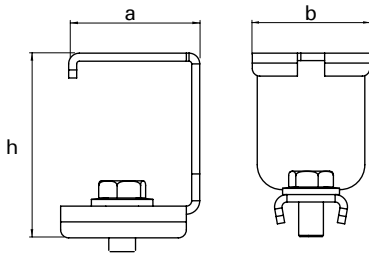

### İkili Tava Askı Takımı

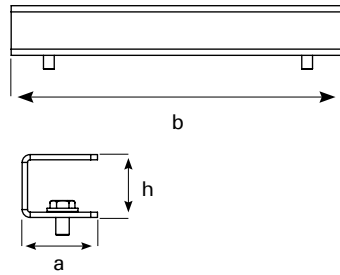

### Mapa Tekli Askı Takımı

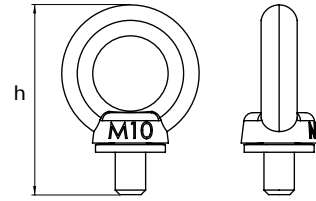

### Ölçüler (mm)

	a	b	h
Tekli Tava Askı Takımı	49	47	69
İkili Tava Askı Takımı	56	310	48
Mapa Askı Takımı	-	-	63

### Deve Boynuna Montaj Özelliği



# CUSHIDO

-25°C +55°C



- Petrol Rafinerileri
- Boya ve Melamin Üretim Tesisleri
- Petrokimya ve Kimya
- Benzin istasyonları

## Yüksek performanslı Ex-Proof armatür

- ✓ Patlamaya ve yanmaya duyarlı, hassas bölgeler için ideal tercih
- ✓ IP66 koruma & IK10 darbe dayanım sınıfı / Polikarbonat gövde ve difüzör
- ✓ -25°C'den +55°C'ye kadar ortam çalışma sıcaklığı
- ✓ 3 saate kadar acil kit seçeneği / Akıllı aydınlatma için farklı tip sürücü seçenekleri
- ✓ Patlayıcı ve yanıcı sahalar için bölge sınıflandırması: Bölge 2/22



**CUSHIDO**

43 W – 71 W  
6100 lm – 10100 lm

**OPTİK**  
Geniş Açılı

## Teknik Çizim

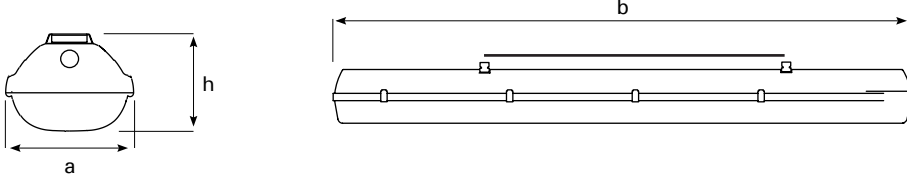

## Ölçüler (mm)

	a	b	h
120 cm	145	1272	111
150 cm	145	1572	111

## Ağırlık (kg)

120 cm	3,4
150 cm	4,4

# PROLIT EX-PROOF



- Lojistik
- Tersaneler
- Tanker Dolum ve Boşaltım Alanları
- Petrol Rafinerileri
- Akaryakıt Gemileri

-20°C +55°C



## Zorlu çevre koşulları için Ex-Proof projektör

- ✓ Yüksek verimlilik sağlayan gelişmiş Ex-Proof projektör
- ✓ IP66 koruma & IK09 darbe dayanım sınıfı / Temperli serigrafi cam
- ✓ -20°C'den +55°C'ye kadar ortam çalışma sıcaklığı
- ✓ Zorlu çevre koşulları için özel tasarım
- ✓ Geniş lümen paketi ve çeşitli optik seçenekleri
- ✓ DALI kontrol seçeneği
- ✓ Patlayıcı ve yanıcı sahalar için bölge sınıflandırması: Bölge 2/22 Grup / Kategori: II / 3GD Koruma sınıfı: ec / tc



### PROLIT EX-PROOF

102 W – 206 W  
13716 lm – 25760 lm

**OPTİK**  
22° / 32° / 57° / 99° / AS



### PROLIT KOMPAKT EX-PROOF

40 W – 96 W  
5100 lm – 11366 lm

**OPTİK**  
16° / 90° / AS / DA



**Teknik Çizim | Ex-Proof**

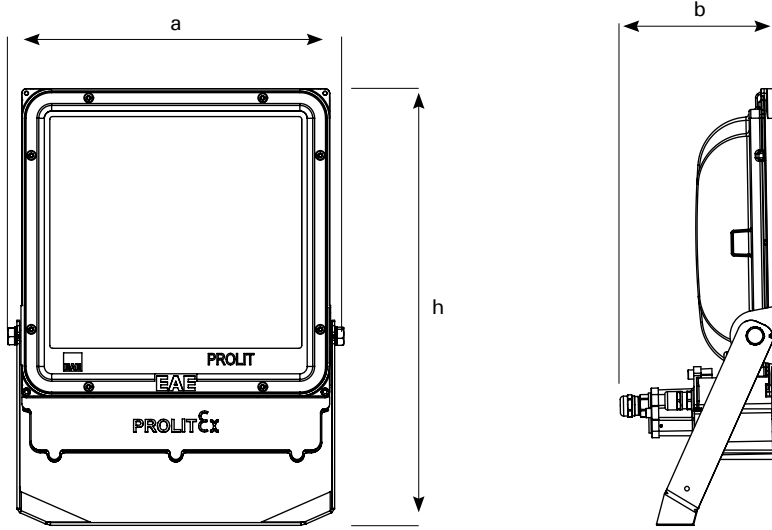

**Teknik Çizim | Kompakt Ex-proof**

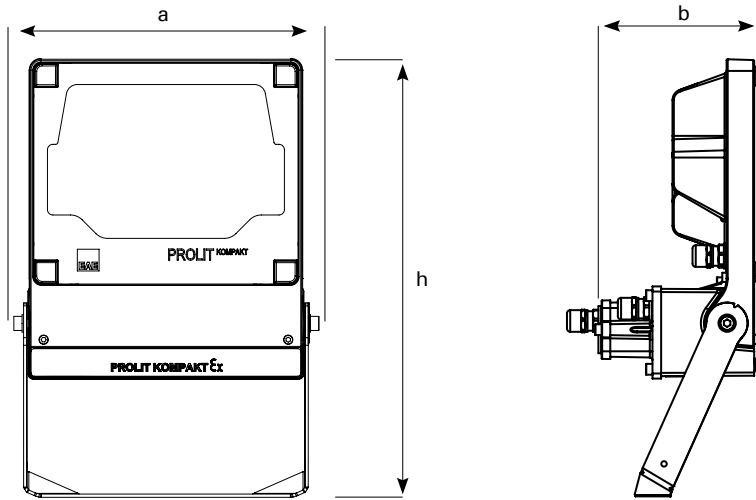

**Ölçüler (mm)**

	a	b	h
Prolit Ex-Proof	279	173	476
Prolit Kompakt Ex-Proof	281	149	404

**Ağırlık (kg)**

Prolit Ex-Proof	7,1
Prolit Kompakt Ex-Proof	5,3

# PROLIT KOMPAKT



- Lojistik
- Tersaneler
- Tanker Dolu ve Boşaltım Alanları
- Petrol Rafinerileri
- Akaryakıt Gemileri

-30°C +55°C



## Değişken uygulamalar için kompakt aydınlatma çözümü

- ✓ Konvansiyonel projektörlerin verimli alternatifi
- ✓ IP66 koruma & IK08 darbe dayanım sınıfı
- ✓ -30°C'den +55°C'ye kadar ortam çalışma sıcaklığı
- ✓ DALI kontrolü ile %53'ten %70'e kadar enerji tasarrufu
- ✓ Tünel / Denizcilik için özel gövde uyarlamaları  
Prolit Tünel / Prolit Ship



### PROLIT KOMPACT V3 / NG

30 W – 124 W  
4000 lm – 14400 lm

#### OPTİK

16° / 18° / 22° / 23° / 27° /  
35° / 46° / 52° / 60° / 90° /  
98° / 99° / AS / Spor lens / 0 Tilt

## Teknik Çizim

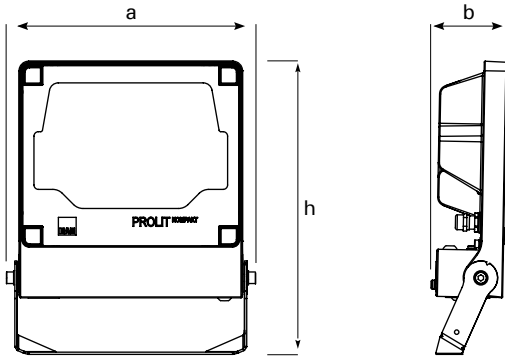

## Ölçüler (mm)

	a	b	h
Standart	280	76	330

## Ağırlık (kg)

Standart	3,6
----------	-----

## Boru Bağlantı Askı Takımı

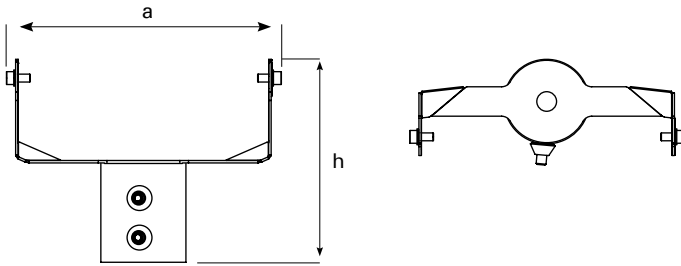

## Ölçüler (mm)

	a	h
Boru Montaj Askı Takımı	277	205

## Terminal Kutulu Opsiyonel Versiyon

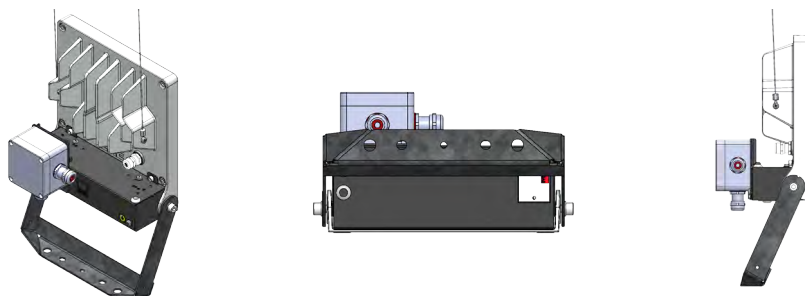

# PROLIT



- Açık Alanlar
- Limanlar
- Spor Salonları
- Endüstriyel Tesisler
- Çeşitli Park Yerleri
- Reklam Panoları
- Bina Cepeleri

-30°C +60°C



## Projektör uygulamaları için ultra yüksek performanslı armatür

- ✓ Ultra yüksek güçlü LED projektör
- ✓ IP66 koruma & IK09 darbe dayanım sınıfı
- ✓ -30°C'den +60°C'ye kadar ortam çalışma sıcaklığı
- ✓ 400 W Metal Halide armatür performansına denktir
- ✓ %65'ten %80'e varan enerji tasarrufu
- ✓ Tünel / Gemi için özel gövde uyarlamaları
- ✓ DALI / DIMKO / 1-10V / RF kontrol seçenekleri



### PROLIT NG / MP

94 W – 230 W  
12494 lm – 28306 lm

**OPTİK**  
10° / 99° / AS / Spor lens /  
0 Tilt



### PROLIT SHIP

101 W – 206 W  
13400 lm – 25800 lm

**OPTİK**  
10° / 99° / AS / Spor lens /  
0 Tilt

## Teknik Çizim

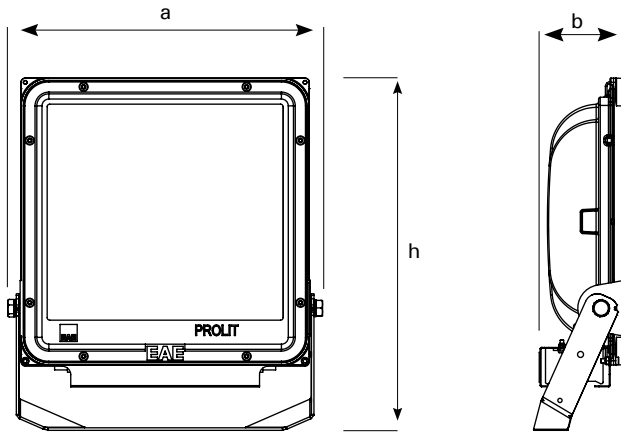

## Ölçüler (mm)

	a	b	h
Standart	336	95	412

## Ağırlık (kg)

Standart	7,1
----------	-----

## Boru Montaj Askı Takımı

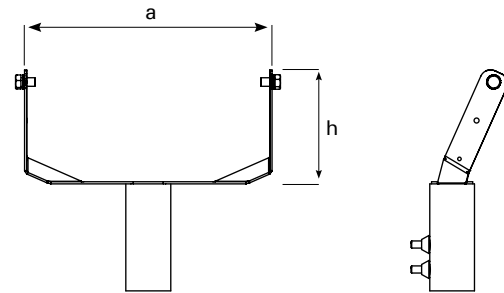

## Ölçüler (mm)

	a	b	h
Boru Montaj Askı Takımı	345	-	310
Tek Noktalı Askı Takımı	345	-	345

## Tek Noktalı Askı Takımı

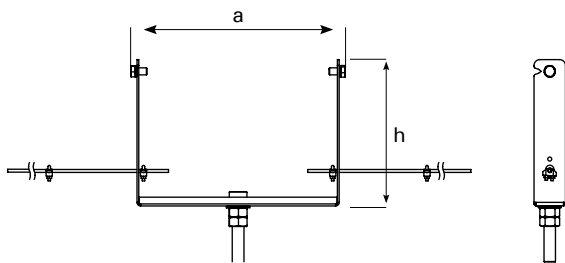

# PROLIT PLUS



- Genel Açık Alanlar
- Limanlar
- Spor Salonları
- Endüstriyel Tesisler
- Otoparklar
- Bina Cepheleri

-30°C +60°C



## Geniş alanların aydınlatma çözümü

- ✓ Liman / Apron / Tünel için özel gövde uyarlamaları
- ✓ IP66 koruma & IK09 darbe dayanım sınıfı / Temperli serigrafi cam
- ✓ -30°C'den +60°C'ye kadar ortam çalışma sıcaklığı
- ✓ DALI / 1-10V / DIMKO / RF kontrol seçenekleri



### PROLIT PLUS

195 W – 435 W  
25300 lm – 58706 lm

#### OPTİK

16° / 18° / 23° / 27° / 30° / 35° / 45° /  
46° / 52° / 60° / 90° / 98° / AS /  
Sport lens / 0 Tilt

## Teknik Çizim

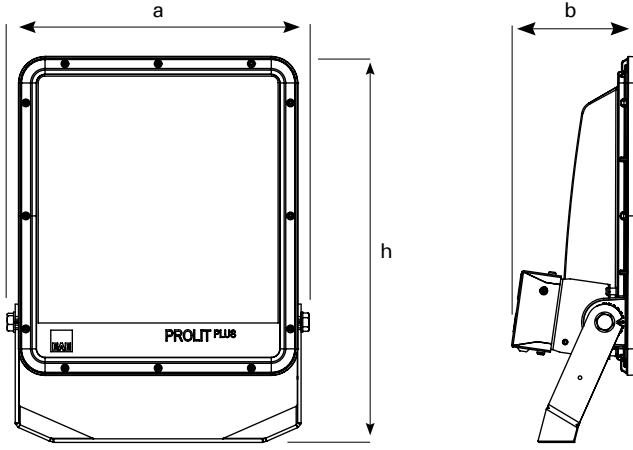

## Ölçüler (mm)

	a	b	h
Standart	424	174	537



## Ağırlık (kg)

Standart	11,5
----------	------

## Ölçüler (mm)

	a	b	h
Köşe Askı Takımı	422	-	331
Kolay Montaj Askı Takımı	399	-	-
Dörtlü Tek Açı Askı Takımı	870	-	-
Döner Askı Takımı 1x	-	-	286
İkili Boru Askı Takımı	-	-	600
Dikey Boru Askı Takımı	220	-	160
Döner Askı Takımı	690	78	

## Köşe Askı Takımı

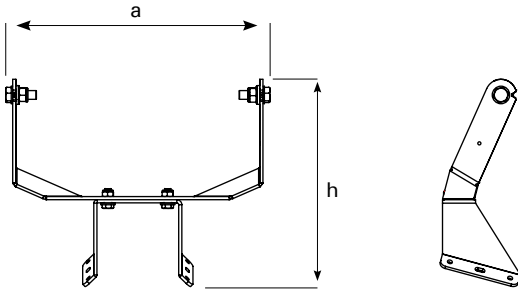

## Dörtlü Tek Açı Askı Takımı

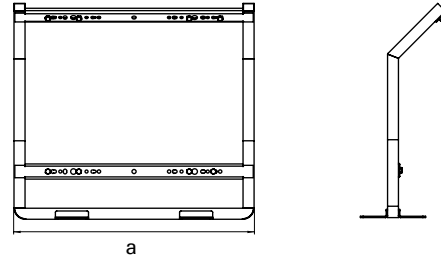

## Kolay Montaj Askı Takımı

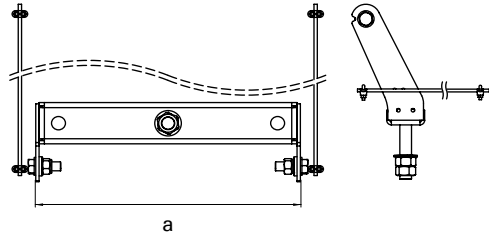

## İkili Boru Askı Takımı

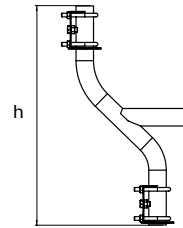

## Döner Askı Takımı 1x

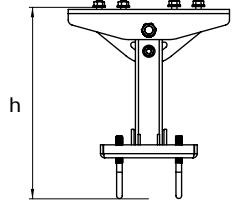

## Dikey Boru Askı Takımı

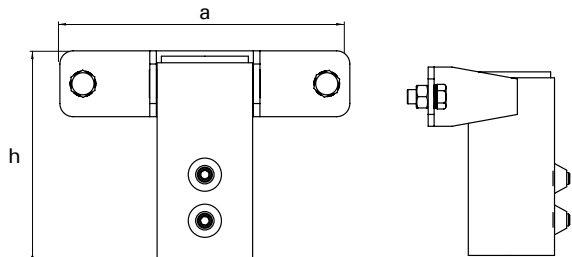

## Döner Askı Takımı

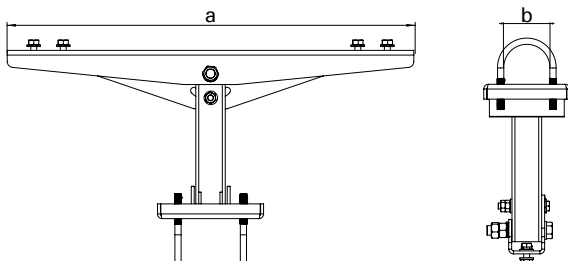

# PROLIT

## Plus Apron



■ Havaalanları

-30°C +50°C



## Havaalanı pistleri için tasarlanmıştır

- ✓ Metalize kaplı plastik reflektör
- ✓ IP66 koruma & IK10 darbe dayanım sınıfı
- ✓ -30°C'den +50°C'ye kadar ortam çalışma sıcaklığı
- ✓ Havaalanları için özel geliştirilen asimetrik optik
- ✓ DALI / 1-10V / DIMKO / RF kontrol seçenekleri



### PROLIT Plus Apron Tekli

211 W – 354 W  
24481 lm – 41391 lm

**OPTİK**  
Havaalanlarına Özel Lens



### PROLIT Plus Apron İkili

422 W – 708 W  
49682 lm – 82782 lm

**OPTİK**  
Havaalanlarına Özel Lens



### Teknik Çizim

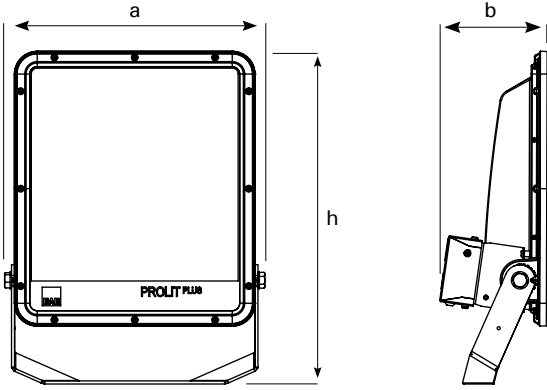

### Ölçüler (mm)

	a	b	h
Tekli	424	171	537
İkili	824	173	525

### Ağırlık (kg)

Tekli	12,5
İkili	25

### Teknik Çizim

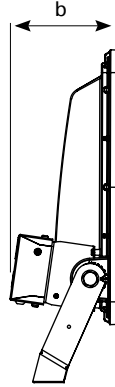
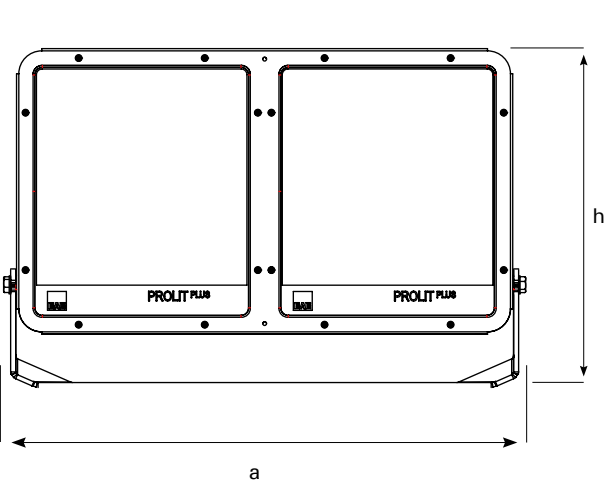

# PROLIT EFFECT



- Tersaneler
- Limanlar
- Uçak Hangarları
- Açık Alan Aydınlatması

-30°C +55°C



## Küresel pazardaki en hafif ve en verimli projektör

- ✓ Dayanıklı cephe ve alan armatürü
- ✓ IP66 koruma & IK09 darbe dayanım sınıfı / Temperli ve ekran baskılı cam difüzör
- ✓ -30°C'den +55°C'ye kadar ortam çalışma sıcaklığı
- ✓ DALI kontrol seçeneği



### PROLIT EFFECT

420 W – 770 W  
56421 lm – 102371 lm

#### OPTİK

10° / 13° / 16° / 18° / 22° /  
23° / 27° / 30° / 46° / 54° /  
57° / 60° / 90° / 98°  
SP / AS / 0 Tilt

### Teknik Çizim

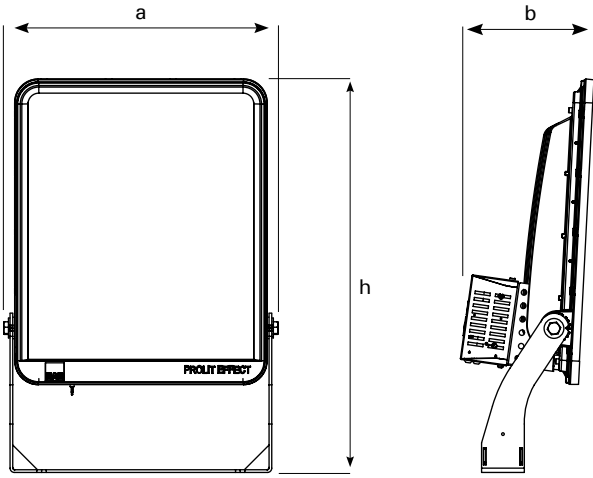

### Ölçüler (mm)

	a	b	h
Tekli	512	270	731

### Ağırlık (kg)

Standart	18,8
----------	------

### Askı Takımı

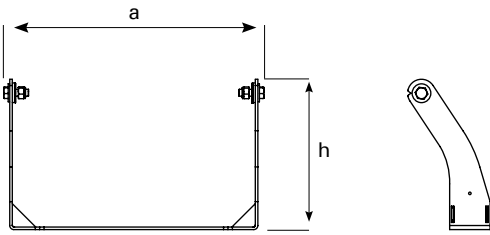

### Ölçüler (mm)

	a	b	h
Askı Takımı	487	-	295

# MFL

-30°C +55°C



- Tersaneler
- Limanlar
- Yolcu Gemisi Cepheleri

## Denizcilik uygulamaları için yenilikçi projektör

- ✓ Denizcilik uygulamaları için LED projektör
- ✓ Marine boyası sayesinde korozyona karşı yüksek dayanım
- ✓ IP66 koruma & IK10 darbe dayanım sınıfı
- ✓ -30°C'den +55°C'ye kadar ortam çalışma sıcaklığı
- ✓ DALI kontrol seçeneği



**MFL**

65 W – 164 W  
9295 lm – 24364 lm

Mid Power LED

**OPTİK**  
55° / 90°

### Teknik Çizim

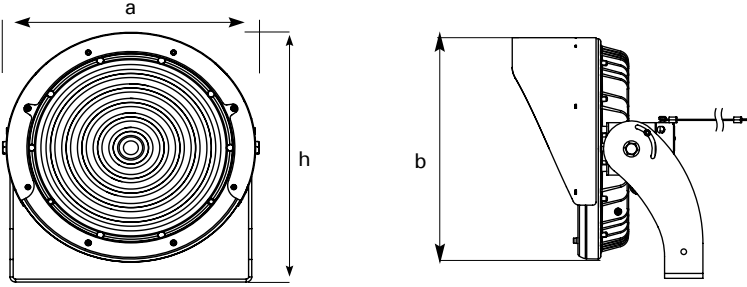

### Ölçüler (mm)

	a	b	h
Tekli	327	316	344

### Ağırlık (kg)

Standart	8,1
----------	-----

### Askı Takımı

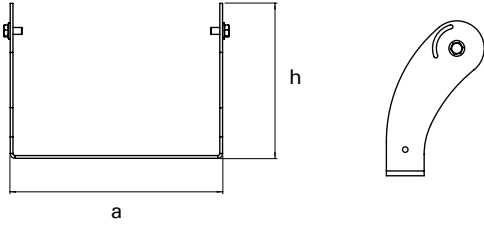

### Ölçüler (mm)

	a	b	h
Askı Takımı	308	-	225

# VALERIA



- Açık Alanlar
- Limanlar
- Spor Salonları
- Endüstriyel Tesisler
- Park Yerleri
- Reklam Panoları
- Bina Cepheleri

-20°C +40°C



## Geniş alanların aydınlatma ihtiyaçları için mükemmel çözüm

- ✓ Maksimum performans, mükemmel dayanıklılık
- ✓ IP66 koruma & IK08 darbe dayanım sınıfı
- ✓ -20°C'den +40°C'ye kadar ortam çalışma sıcaklığı
- ✓ DALI kontrol seçeneği



### VALERIA

45 W – 292 W  
5616 lm - 37938 lm

Temperli Cam - Kumlu Cam

**OPTİK**  
60° / 90°

## Teknik Çizim

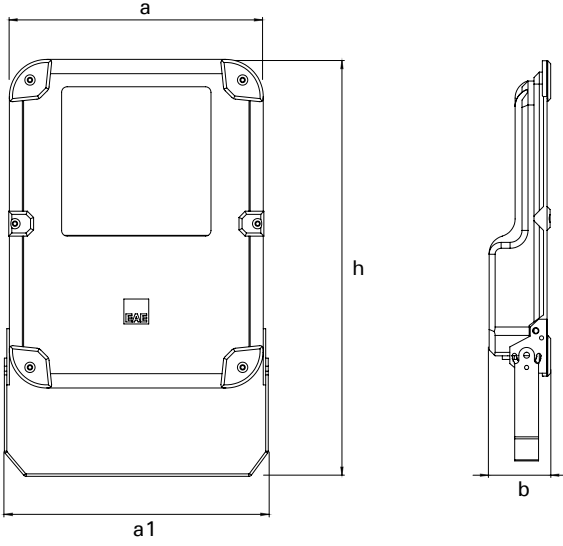

## Ölçüler (mm)

	a	a1	b	h
Standart	205	212	50	335

## Ağırlık (kg)

Standart	6,7
----------	-----

# RA / RA2 / RA3

-40°C +60°C



- Sokaklar
- Köprüler
- Bisiklet ve Yaya Yolları
- Otoparklar
- Çevre Aydınlatması
- Yollar ve Otoyollar

## Sokak aydınlatmasının en iyi hali

- ✓ Direk üstü, güçlü LED armatür
- ✓ IP66 koruma & IK08 - IK09 darbe dayanım sınıfı
- ✓ -40°C'den +60°C'ye kadar ortam çalışma sıcaklığı
- ✓ İsteğe bağlı yalıtım koruma sınıfı ( Class I ve Class II )
- ✓ DALI, DIMKO, NEMA, Zhaga ve RF üzerinden akıllı aydınlatma kontrol sistemi



### RA

25 W – 58 W  
3558 lm – 7962 lm

#### OPTİK

100° / 110° / Geniş Açılı / Ekstra Geniş Açılı

RF Wireless and DALI /1-10V  
DIMKO / Nema / Zhaga  
kontrol seçenekleri



### RA 2

30 W – 116 W  
3637 lm – 16906 lm

#### OPTİK

100° / 110° / Geniş Açılı / Ekstra Geniş Açılı

RF Wireless and DALI /1-10V  
DIMKO / Nema / Zhaga  
kontrol seçenekleri



### RA 3

103 W – 218 W  
15300 lm – 27700 lm

#### OPTİK

100° / 110° / Geniş Açılı / Ekstra Geniş Açılı

RF Wireless and DALI /1-10V  
DIMKO / Nema / Zhaga  
kontrol seçenekleri



**Teknik Çizim**

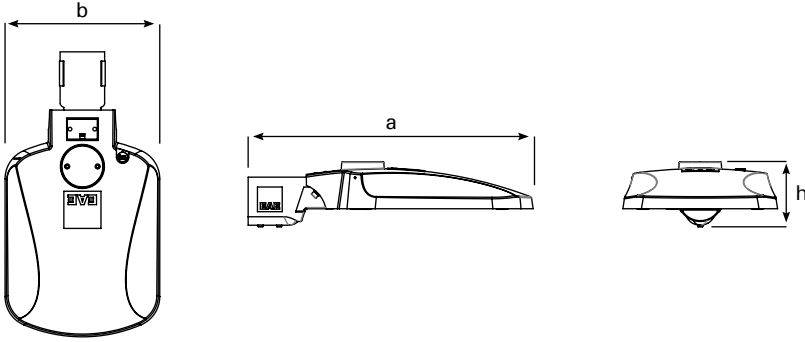

**Ölçüler (mm)**

	a	b	h
Ra	250	460	105
Ra2	310	639	104
Ra3	310	705	104

**Ağırlık (kg)**

Ra	3,4
Ra2	6,7
Ra3	8,3

# HORUS 1-2

-20°C +35°C



- Sokak ve Çevre
- Limanlar
- Kara Yolları
- Tersaneler
- Açık Alanlar
- Kentsel Alanlar

## Modern, yüksek verimli sokak ve çevre aydınlatması

- ✓ Sokak aydınlatması için son derece dayanıklı LED armatür
- ✓ IP66 koruma & IK08 darbe dayanım sınıfı / Temperli şeffaf cam
- ✓ -20°C'den +35°C'ye kadar ortam çalışma sıcaklığı
- ✓ DALI / 1-10V + DIMKO seçenekleri
- ✓ Kolay değişim imkânı sağlayan driver bölmesi



### HORUS-1

79 W – 123 W  
10200 lm – 13500 lm

Mid Power LED

**OPTİK**  
100°



### HORUS-2

117 W – 195 W  
15700 lm – 23044 lm

Mid Power LED

**OPTİK**  
100°

**Teknik Çizim**

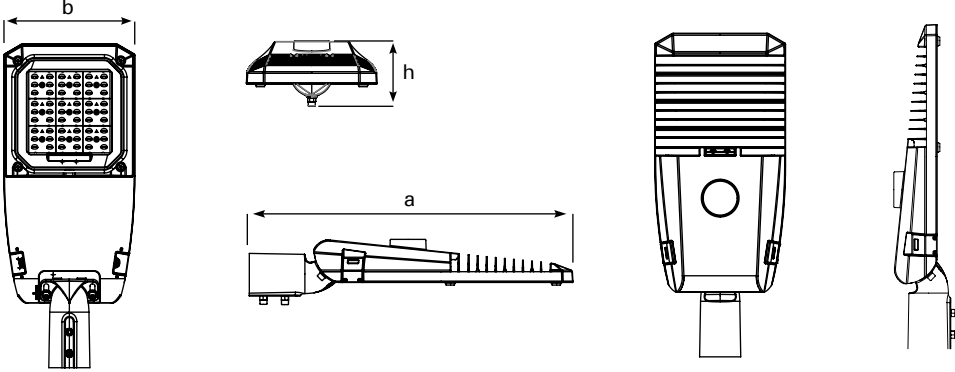

**Ölçüler (mm)**

	a	b	h
Horus 1	601	243	120
Horus 2	721	313	120

**Ağırlık (kg)**

Horus 1	3,5
Horus 2	5,1

# OSIRIS

-20°C +40°C



- Sokak ve Çevre
- Limanlar
- Kara Yolları
- Tersaneler
- Açık Alanlar
- Kentsel Alanlar

## Yüksek performanslı sokak aydınlatması

- ✓ M1 ve diğer tüm yol sınıflarına uygun armatür
- ✓ IP66 koruma & IK09 darbe dayanım sınıfı / Temperli şeffaf cam
- ✓ Hızlı ve kolay kurulum
- ✓ -20°C'den +40°C'ye kadar ortam çalışma sıcaklığı
- ✓ Yüksek enerji tasarrufu
- ✓ DALI kontrol seçeneği
- ✓ Kolay değişim imkânı sağlayan kapaklı driver



OSIRIS

237 W – 375 W  
30430 lm – 48352 lm

OPTİK  
Mid Power LED  
100°

**Teknik Çizim**

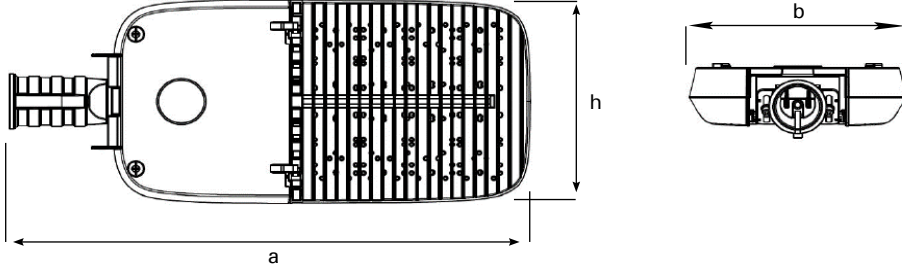

**Ölçüler (mm)**

	a	b	h
Standart	910	320	112

**Ağırlık (kg)**

Standart	10,5
----------	------

# ARKTOS

## NG



- Sokak ve Çevre
- Limanlar
- Kara Yolları
- Tersaneler
- Açık Alanlar
- Kentsel Alanlar

-40°C +50°C



## Çevre aydınlatması için mükemmel performans

- ✓ Dış ortam koşullarında maksimum dayanım
- ✓ Alüminyum enjeksiyon monoblok gövde
- ✓ IP66 koruma & IK09 darbe dayanım sınıfı /  
Temperli şeffaf cam
- ✓ Yüksek enerji tasarrufu ve uzun ömürlü kullanım
- ✓ -40°C'den +50°C'ye kadar ortam çalışma sıcaklığı
- ✓ Sıfır civa ile çevre dostu aydınlatma



### ARKTOS

55 W – 142 W  
7100 lm – 15656 lm

Mid Power LED

OPTİK  
110°

## Teknik Çizim

---

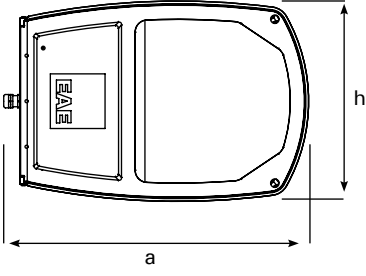

## Ölçüler (mm)

---

	a	b	h
Standart	475	92,5	330

## Ağırlık (kg)

---

Standart	6
----------	---



- Lojistik
- Veri Merkezleri
- Tekstil
- Perakende ve Sunum
- Ofis ve İletişim
- Eğitim ve Bilim
- Sanat ve Kültür
- Market

## Mükemmel aydınlatma deneyimi

- ✓ Kesintisiz aydınlatma hatları oluşturabilmek amacıyla tasarlanmış gövde tasarımı
- ✓ Basit, hızlı ve aletsiz kurulum
- ✓ IP20 - IP40 - IP64 koruma & IK02 darbe dayanım sınıfı
- ✓ -20°C'den +74°C'ye kadar ortam çalışma sıcaklığı
- ✓ UGR < 19 seçeneği
- ✓ 5'ten 11'e kadar iletken ara gövde
- ✓ Alüminyum gövde



### INFINOO IP20 / IP 40

20 W – 197 W  
3200 lm – 25583 lm

**OPTİK**  
30° / 60° / 90° / AS /  
DA

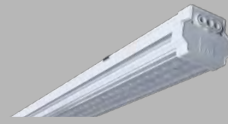

### INFINOO IP64

20 W – 197 W  
3200 lm – 25583 lm

**OPTİK**  
30° / 60° / 90° / AS /  
DA



### INFINOO DUO

93 W – 192 W  
15744 lm – 27709 lm

**OPTİK**  
30° / 60° / 90° / AS /  
DA





**INFINOO**  
**OPAL IP20 & IP40**

36 W – 98 W  
4439 lm – 11156 lm

Opal Difüzör



**INFINOO**  
**OPAL IP64**

25 W – 106 W  
2800 lm – 12051 lm

Opal Difüzör

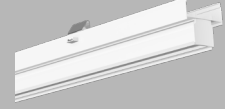

**INFINOO**  
**TRACK**

Üç Fazlı Kanal Rayı  
INFINOO LINE



**INFINOO**  
**SENSOR**

Sensör Ünitesi ile Uyumlu  
INIFINOO LINE  
Kanal Rayı



**INFINOO**  
**EXIT**

Acil Durum Ünitesi ile Uyumlu  
INIFINOO LINE  
Kanal Rayı



**INFINOO**  
**COVER**

Metal veya Bilgisayar  
Kapakları ile Uyumlu INIFINOO  
Kanal Rayı

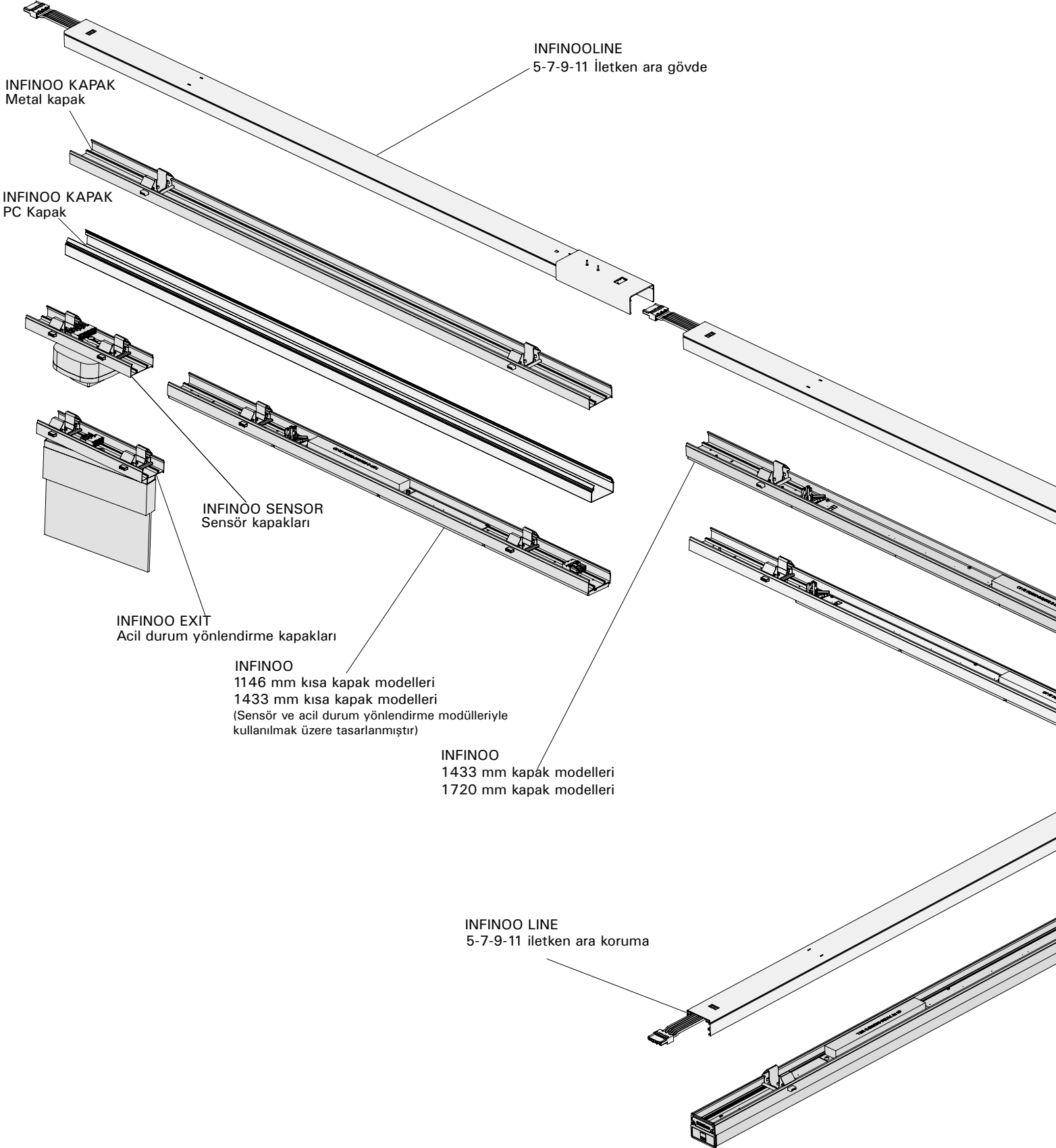

## Aski Takımı

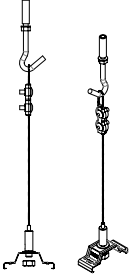

ÇELİK FİBER TAKVİYELİ  
BETON ASKI TAKIMI

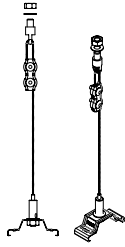

ÇELİK FİBER-KABLO  
KANALI ASMA TAKIMI

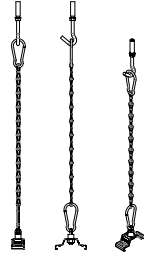

ÇELİK FİBER-KABLO  
ASKI TAKIMI

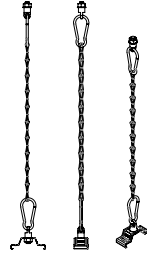

ZİNCİR BETON KABLO  
TEPSİ ASKI TAKIMI

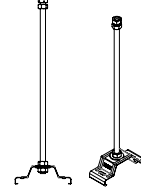

ÇUBUKLU KABLO  
KANALI  
ASKI TAKIMI

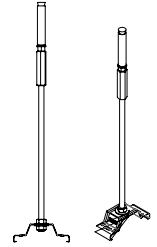

ÇUBUK-BETON  
ASKI TAKIMI

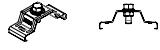

YAYLI DESTEK KABLOSU  
TEPSİ MONTAJ ALETİ

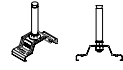

YAY BETONU DESTEK  
MONTAJ ALETİ

INFINOO LINE  
5-7-9-11 iletken  
ara gövde

INFINOO RAY  
Üç fazlı ray 1433mm kapak modelleri  
Üç fazlı ray 1720mm kapak modelleri

X Dönüş

T Dönüş

L Dönüş

INFINOO DUO

# M-LINE

-20°C +40°C



- Lojistik
- Eğitim ve Bilim
- Kompleksler
- Mağazalar ve Marketler
- Ofis ve İdari Binalar

## Sonsuz aydınlatma uygulamaları için uygun maliyetli alternatif

- ✓ Yüksek performanslı ve uzun ömürlü LED armatür
- ✓ IP40 koruma & IK02 darbe dayanım sınıfı
- ✓ -20°C'den +40°C'ye kadar ortam çalışma sıcaklığı
- ✓ Sıva üstü modüler aydınlatma
- ✓ Kullanım alanına göre farklı gövde boyutları
- ✓ Opal difüzör seçeneği
- ✓ 3 saate kadar acil kit seçeneği / Akıllı aydınlatma için farklı tip sürücü seçenekleri



### M-LINE

11 W – 75 W  
1540 lm – 10240 lm

**OPTİK**  
30° / 60° / 90° /  
DA / Batwing

## Teknik Çizim

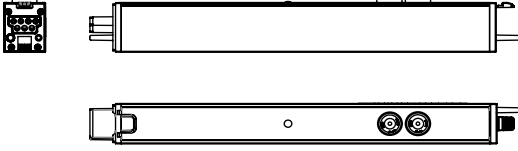

## Ortadan Besleme Modülü

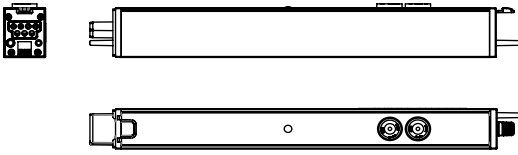

## Baştan Besleme Modülü

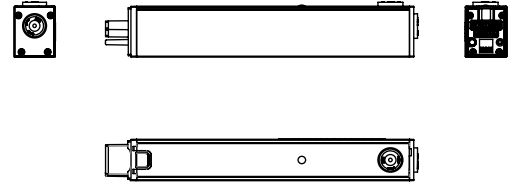

## Ara Modül

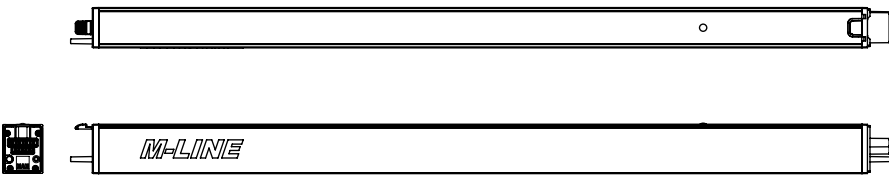

## Sonlandırma Modülü

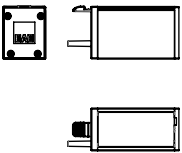

## Ağırlık (kg)

Tekli Modül	1,56
Boş Modül	1,15
Ara Modül	1,76
Ortadan Besleme Modülü	0,46
Baştan Besleme Modülü	0,35
Sonlandırma Modülü	0,1

## Askı Takımları

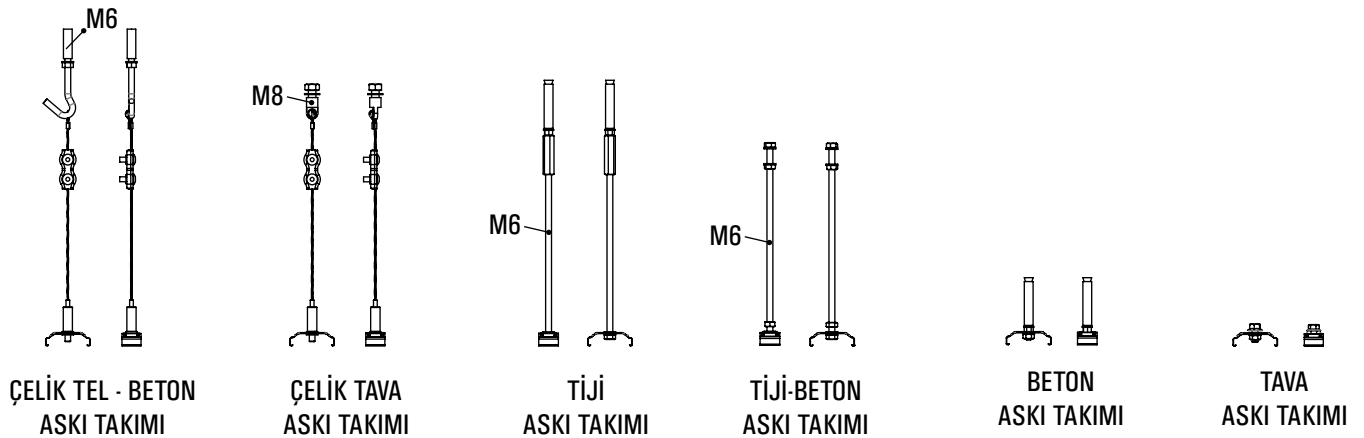

# GALIS MEGA

-25°C +40°C



- Lojistik
- Kompleks Binalar
- Mağazalar ve Marketler
- Ofis ve İdari Binalar

## Esnek kullanım için ideal çözüm

- ✓ Maksimum enerji tasarrufu
- ✓ IP65 koruma & IK09 darbe dayanım sınıfı / Alüminyum ekstrüzyon gövde
- ✓ -25°C'den +40°C'ye kadar ortam çalışma sıcaklığı
- ✓ Dereceli askı takımı sayesinde esnek montaj opsiyonu
- ✓ Kablo rakoru sayesinde hızlı ve kolay elektrik bağlantısı
- ✓ 3 saate kadar acil durum kit seçeneği / DALI kontrolü
- ✓ Normal ve Through-Wiring kablolama seçenekleri



### GALIS Mega

25 W – 130 W  
3500 lm – 18800 lm

#### OPTİK

15° / 25° / 40° / 60° / 90° /  
AS



### GALIS Mega - Temperli Cam + Lens

25 W – 130 W  
3500 lm – 18800 lm

#### OPTİK

15° / 25° / 40° / 60° / 90°

## Teknik Çizim | Yandan Besleme

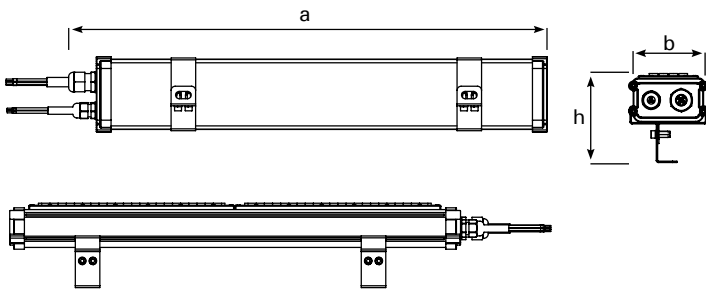

### Ölçüler (mm)

	a	b	h
Galis Mega Yandan Besleme	585	93	107
Galis Mega Üstten Besleme	556	93	132

## Teknik Çizim | Üstten Besleme

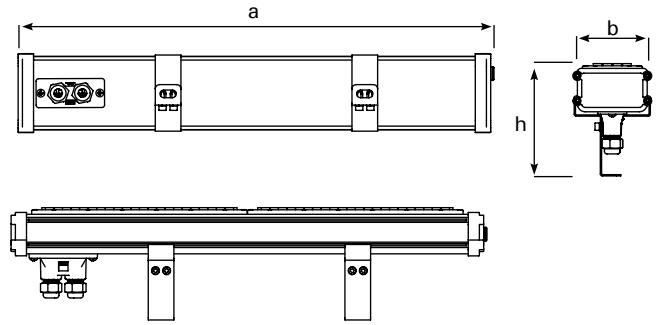

### Ağırlık (kg)

Standart	1,7
Standart ACK	2
DALI + ACK	2

## Sabit Askı Takımı

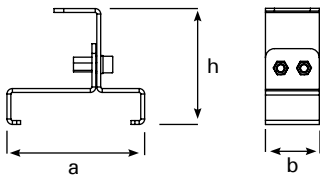

## Dereceli İkili Askı Takımı

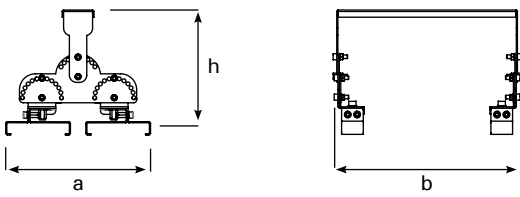

## Dereceli Üçlü Askı Takımı

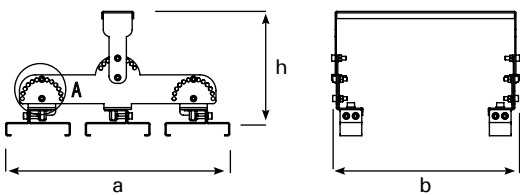

## Dereceli Askı Takımı

(Paslanmaz Çelik Versiyon)

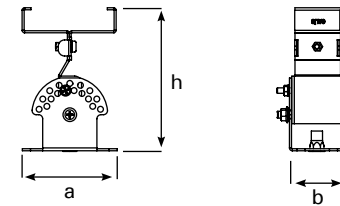

## İkili Askı Takımı

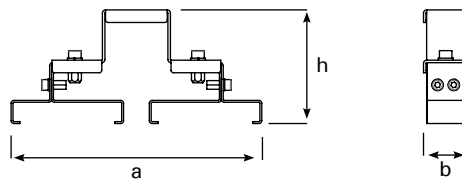

### Ölçüler (mm)

	a	b	h
Sabit Askı Takımı	89	30	63
Dereceli Askı Takımı	90	41	105
Dereceli İkili Askı Takımı	200	243	172
Dereceli İkili Askı Takımı	199	36	90
Dereceli Üçlü Askı Takımı	309	250	154

# GALIS

-20°C +40°C



- Lojistik
- Eğitim ve Bilim
- Kompleksler
- Mağazalar ve Marketler
- Ofis ve İdari Binalar

## Zorlu koşullar için maksimum performans

- ✓ Yüksek performanslı su geçirmez LED armatür
- ✓ IP66 - IP69 koruma & IK09 darbe dayanım sınıfı / Alüminyum ekstrüzyon gövde
- ✓ -20°C'den +40°C'ye kadar ortam çalışma sıcaklığı
- ✓ Standart / Mini gövde seçenekleri
- ✓ Dereceli askı takımı sayesinde esnek montaj opsiyonu
- ✓ Hızlı ve kolay elektrik bağlantısı



### GALIS Saydam Cam

19 W – 68 W  
2432 lm – 9547 lm



### GALIS Kumlu Cam

19 W – 68 W  
1980 lm – 7451 lm



### GALIS Mini

10 W – 50 W  
1253 lm – 5892 lm  
(Saydam Cam)

10 W – 36 W  
929 lm – 3924 lm  
(Kumlu Cam)



## Teknik Çizim

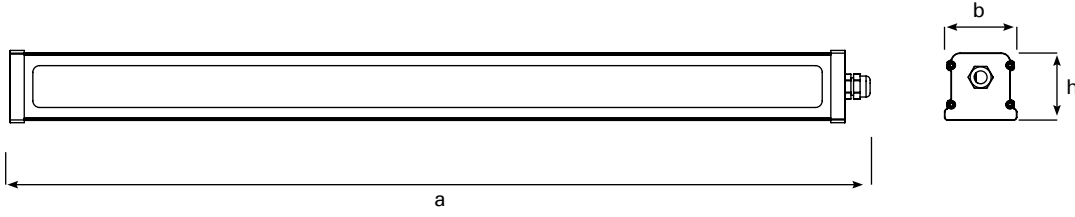

## Ölçüler (mm)

	a	b	h
Galis	1489	76	70,5

## Ağırlık (kg)

Galis	4,4
-------	-----

## Sabit Askı Takımı

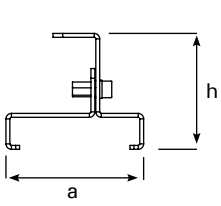

## Dereceli Askı Takımı

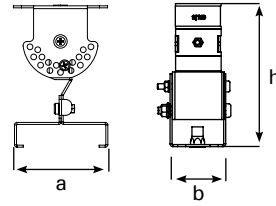

## Destekli Sabit Montaj Takımı

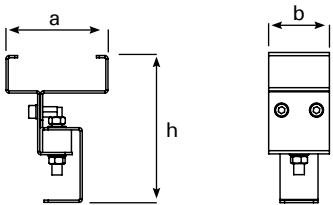

## Sabit Askı Takımı II

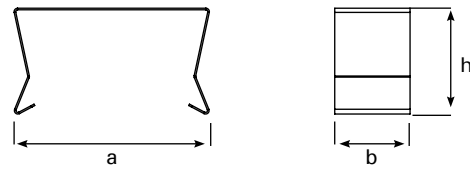

## Ölçüler (mm)

	a	b	h
Sabit Askı Takımı I	71	40	59,4
Dereceli Askı Takımı	69	41	105
Sabit Desteklenen Montaj Kiti	71	40	98
Sabit Askı Takımı II	58	24	34



- Lojistik
- Veri Merkezleri
- Tekstil
- Perakende ve Sunum
- Ofis ve İletişim
- Eğitim ve Bilim
- Sanat ve Kültür

## Çözüm odaklı aydınlatma

- ✓ Ekstrüzyon plastik gövde
- ✓ IP65 koruma & IK09 darbe dayanım sınıfı / Opal PC difüzör
- ✓ Akıllı aydınlatma için farklı tip sürücü ve sensör seçenekleri / Normal ve Through-Wiring kablolama seçenekleri
- ✓ -20°C'den +45°C'ye kadar ortam çalışma sıcaklığı
- ✓ Kolay ulaşılabilir iç aksam
- ✓ Kapalı otoparklar için özel olarak üretilen optik ile daha az ışık hattına ihtiyaç duyulur



### YPB BATWING

24 W – 44 W  
3407 lm – 6072 lm

Batwing

## Teknik Çizim

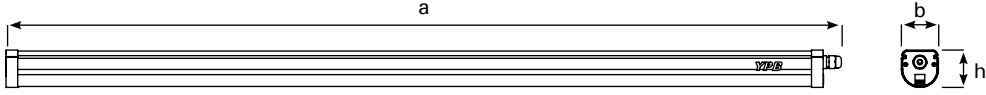

## Ölçüler (mm)

	a	b	h
Standart	915	57	57

## Ağırlık (kg)

Standart	1
----------	---

## Sabit Askı Takımı

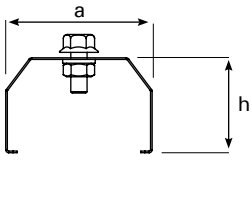

## İkili Beton Destek Montaj Takımı

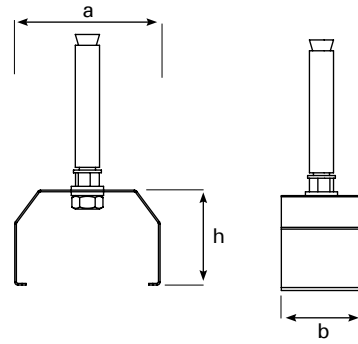

## Dereceli Askı Takımı Sıva Üstü

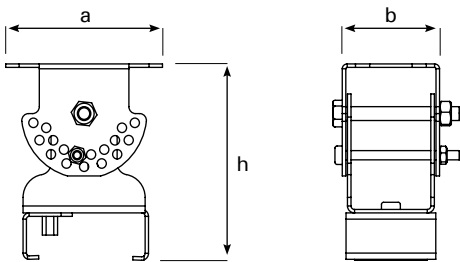

## Ölçüler (mm)

	a	b	h
Sabit Askı Takımı	54	30	35
İkili Beton Destek Montaj Takımı	54	30	35
Dereceli Askı Takımı Sıva Üstü	70	41	85

**LINA**  
**NG**

-20°C +40°C



- Lojistik
- Makine ve Elektronik
- Veri Merkezleri
- Teknik Odalar
- Kanopi Kurulumları
- Çok Katlı Otoparklar
- Soğuk Hava Depoları

## Göz yormayan konforlu aydınlatma

- ✓ Enerji tasarruflu LED armatür
- ✓ IP66 koruma & IK07 darbe dayanım sınıfı / Alüminyum ekstrüzyon gövde
- ✓ -20°C' den +40°C'ye kadar ortam çalışma sıcaklığı
- ✓ Göz yormayan opal difüzör
- ✓ Kolay montaj özelliği
- ✓ Çeşitli ışık açısı seçenekleri
- ✓ Normal ve Through-Wiring kablolama seçenekleri
- ✓ 3 saate kadar acil kit seçeneği / Akıllı aydınlatma için farklı tip sürücü seçenekleri



**LINA**  
**NG**

25 W – 84 W  
2800 lm – 8900 lm

Opal Difüzör

## Teknik Çizim

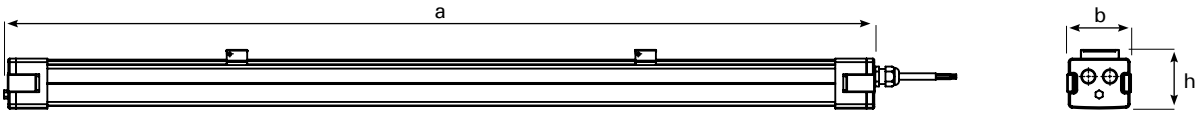

## Ölçüler (mm)

	a	b	h
120 cm	1200	84,7	69,7
150 cm	1500	84,7	69,7

## Ağırlık (kg)

Standart	1
----------	---

## Sabit Askı Takımı

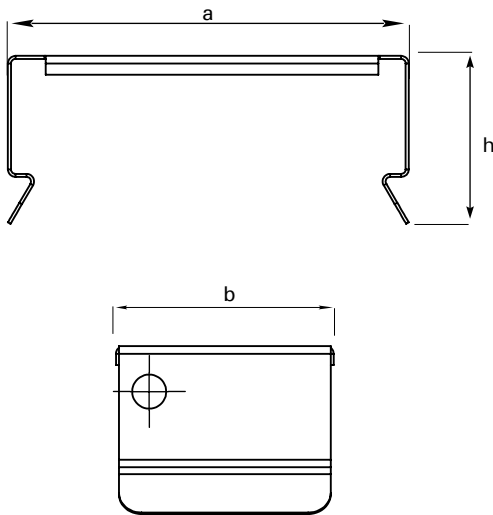

## Dereceli Askı Takımı

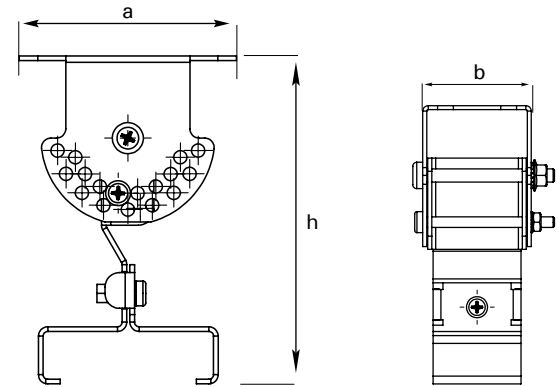

## Ölçüler (mm)

	a	b	h
Sabit Askı Takımı	53	29	22,2
Dereceli Askı Takımı	70	41,2	105,5

# TORNADO

-20°C +35°C



## Dayanıklı, verimli ve konforlu aydınlatma

- Endüstriyel Tesisler
- Havacılık ve Havaalanları
- Kompleks Binalar
- Lojistik
- Metro ve Raylı Sistemler
- Spor Salonları

- ✓ Yüksek korumalı LED armatür
- ✓ IP66 koruma & IK08 darbe dayanım sınıfı
- ✓ -20°C'den +35°C'ye kadar ortam çalışma sıcaklığı
- ✓ 3 saate kadar acil durum kit seçeneği / DALI kontrolü

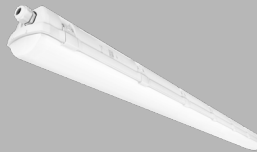

### TORNADO

31 W – 80 W  
4200 lm - 10400 lm

**OPTİK**  
Opal Difüzör

**Teknik Çizim**

---

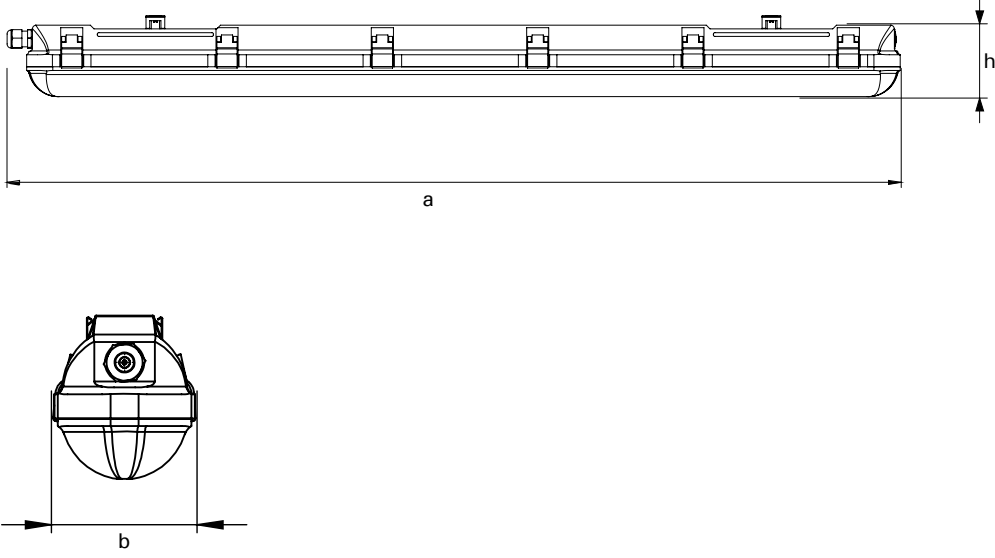

**Ölçüler (mm)**

---

	<b>a</b>	<b>b</b>	<b>h</b>
Standart	1165	89	85

# COZAR

-20°C +40°C



- Endüstriyel Tesisler
- Havacılık ve Havaalanları
- Kompleks Binalar
- Lojistik
- Metro ve Raylı Sistemler
- Spor Salonları

## Nemli alanların ekonomik aydınlatma çözümü

- ✓ IP65 - IP66 koruma & IK09 darbe dayanım sınıfı / Plastik ekstrüzyon gövde
- ✓ -20°C'den +40°C'ye kadar ortam çalışma sıcaklığı
- ✓ 3 saate kadar acil durum kit seçeneği / DALI kontrolü
- ✓ Normal ve Through-Wiring kablolama seçenekleri
- ✓ Kolay montaj özelliği

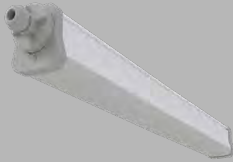

### COZAR IP65 PLUS

19 W – 75 W  
2079 lm – 8347 lm

Opal Difüzör

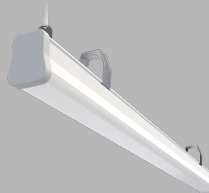

### COZAR IP66

19 W – 75 W  
2079 lm – 8347 lm

Opal Difüzör

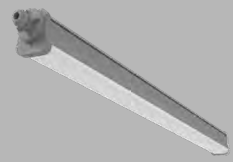

### COZAR PLUS BPL

19 W – 75 W  
2079 lm – 8347 lm

Opal Difüzör



## Teknik Çizim

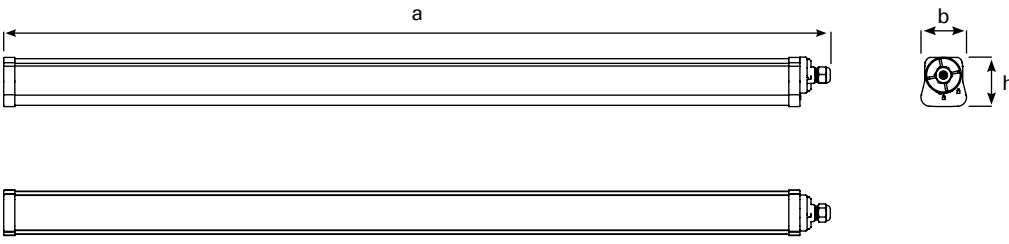

## Ölçüler (mm)

	a	b	h
545 cm	545	69	75
865 cm	865	69	75
1265 cm	1265	69	75
1505 cm	1505	69	75

## Ağırlık (kg)

545 cm	1
865 cm	1,5
1265 cm	1,9
1505 cm	2,2

## Dereceli Askı Takımı

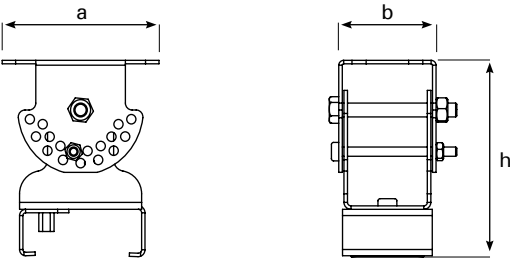

## Uzun Askı Yayı

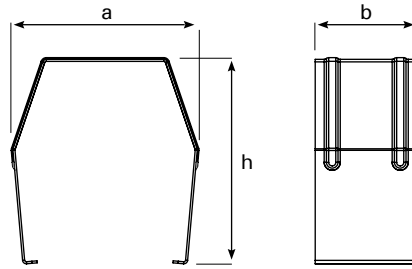

## Tava Askı Takımı

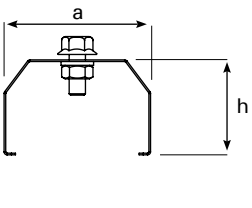

## Duvar Askı Takımı

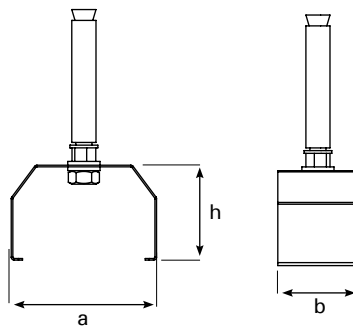

## Ölçüler (mm)

	a	b	h
Dereceli Askı Takımı	70	41	85
Uzun Askı Yayı	55	30	60
Tava Askı Takımı	54	35	30
Duvar Askı Takımı	54	35	30

**YPL**  
**NG**

-20°C +35°C



- Otopark
- Lojistik
- Endüstriyel Alanlar

## Mükemmel performans, yüksek tasarruf

- ✓ IP66 koruma & IK09 darbe dayanım sınıfı / Plastik ekstrüzyon gövde
- ✓ -20°C'den +35°C'ye kadar ortam çalışma sıcaklığı
- ✓ Göz yormayan opal difüzör
- ✓ Akıllı aydınlatma için farklı tip sürücü seçenekleri
- ✓ Normal ve Through-Wiring kablolama seçenekleri



**YPL**  
**NG**

30 W – 53 W  
3013 lm – 5870 lm

Opal Difüzör

## Teknik Çizim

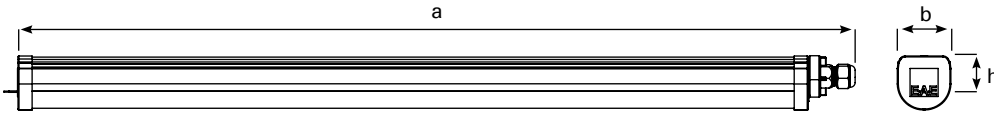

### Ölçüler (mm)

	a	b	h
85 cm	853	57	57
120 cm	1255	57	57
149 cm	1500	57	57

### Ağırlık (kg)

85 cm	0,9
125 cm	1
149 cm	1,3

### Sabit Askı Takımı

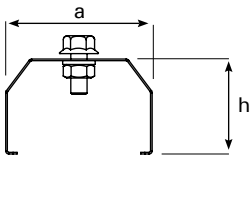

### İkili Beton Destek Montaj Takımı

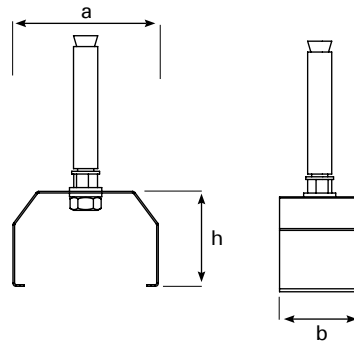

### Dereceli Askı Takımı

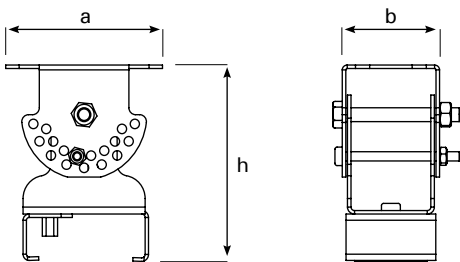

### Ölçüler (mm)

	a	b	h
Sabit Askı Takımı	54	30	35
İkili Beton Destek Montaj Takımı	54	30	35
Dereceli Askı Takımı	70	41	85

# GPRONA

-25°C +50°C



- Tersaneler
- Limanlar
- Gemiler
- Uçak Hangarları
- Yolcu Gemisi Cepheleeri

## Asimetrik bakış açısının en iyi seçimi

- ✓ Ağır sanayi ve liman koşullarına uygun LED armatür
- ✓ IP66 koruma & IK09 darbe dayanım sınıfı / Temperli cam
- ✓ -25°C'den +50°C'ye kadar ortam çalışma sıcaklığı
- ✓ Özel asimetrik eğriye sahip liman sahalarında mükemmel çözüm
- ✓ DALI, RF ile çok yönlü kontrol ve otomasyon / 1-10V ve DIMKO seçenekleri
- ✓ Özel projeler için özel saha çözümlerine uygun
- ✓ Titreşimlere karşı yüksek mukavemet



### GPRONA

135 W – 463 W  
21440 lm – 74200 lm  
DALI / RF / 1-10V / DIMKO

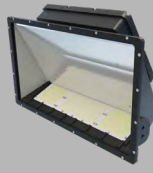

### GPRONA PLUS

558 W – 669 W  
87538 lm – 102604 lm  
DALI / RF / 1-10V / DIMKO

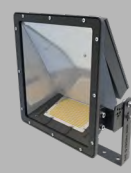

### GPRONA MINI

133 W – 185 W  
21800 lm – 29400 lm  
DALI / RF / 1-10V / DIMKO

## Teknik Çizim

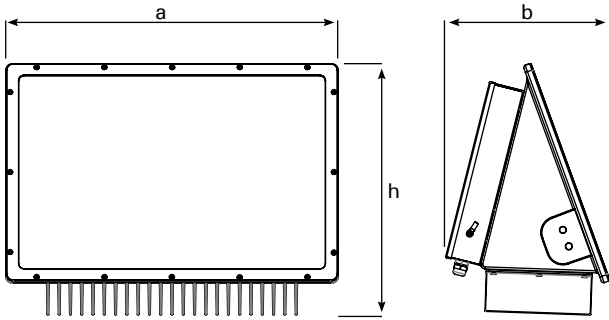

## Ağırlık (kg)

Gprona	22 - 31,5
Gprona Plus	33,5
Gprona Mini	11,8 - 12,3

## Dereceli Askı Takımı

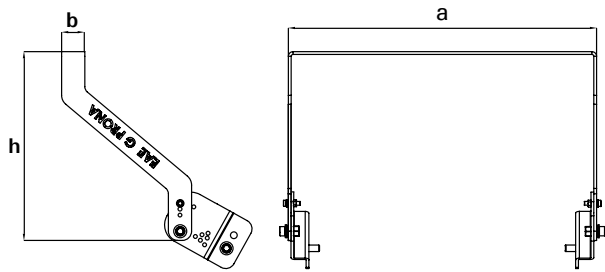

## Kolay Montaj Askı Takımı

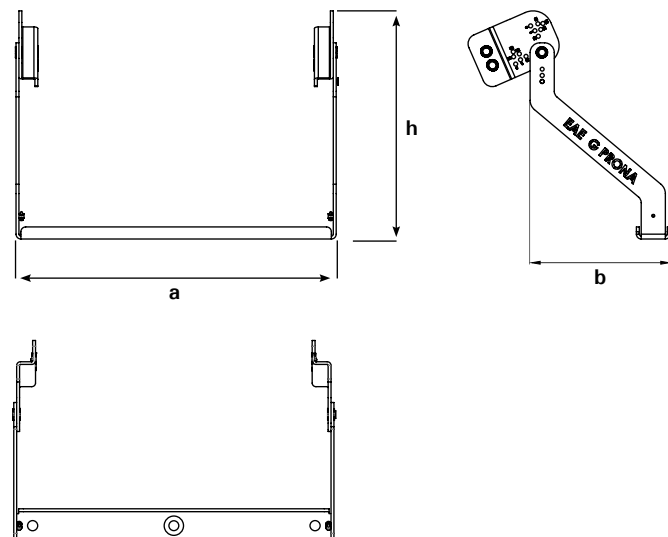

## Ölçüler (mm)

	a	b	h
Gprona Standart Enj. Kutu	589	296	508
Gprona Standart Luxeon Led	589	317	446
Gprona 10V + RF Enj. Kutu	589	296	529
Gprona 10V + RF Luxeon Led	589	403	446
Gprona DALI + ZHAGA Enj. Kutu	589	296	508
Gprona DALI + ZHAGA Luxeon Led	589	340	446

## Ölçüler (mm)

	a	b	h
Gprona Plus Standart	698	297	493
Gprona Plus 10V + RF	698	297	513
Gprona Plus DALI + ZHAGA	698	297	492

## Ölçüler (mm)

	a	b	h
Gprona Mini Standart	374	276	419
Gprona Mini 10V + RF	375	273	483
Gprona Mini DALI + ZHAGA	375	273	445

## U Tipi Kısa Askı Takımı

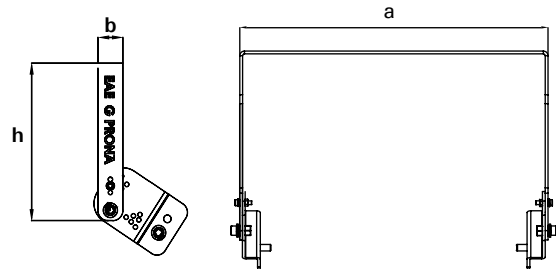

## Ölçüler (mm)

	a	b	h
Dereceli Askı Takımı	662	50	406
U Tipi Kısa Askı Takımı	662	50	306
Kolay Montaj Askı Takımı	662	290	472

# SPRONA

-25°C +45°C

CE

IP66

LED



- Tersaneler
- Limanlar
- Gemiler
- Uçak Hangarları
- Yolcu Gemisi Cepheleri

## Sıra dışı koşullar için maksimum performans

- ✓ Yüksek mekanik dayanıma sahip alüminyum gövde
- ✓ IP66 koruma & IK07 darbe dayanım sınıfı / Temperli şeffaf cam
- ✓ Optimize edilmiş; tekli, ikili ve üçlü modüler kullanım
- ✓ Özel askı takımı ile liman ve dış mekân uygulamalarında fonksiyonel kullanım
- ✓ -25°C'den +45°C'ye kadar ortam çalışma sıcaklığı

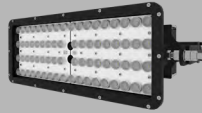

SPRONA

348 W  
49527 lm – 51506 lm

OPTİK  
20° / 35° / 60°

## Teknik Çizim

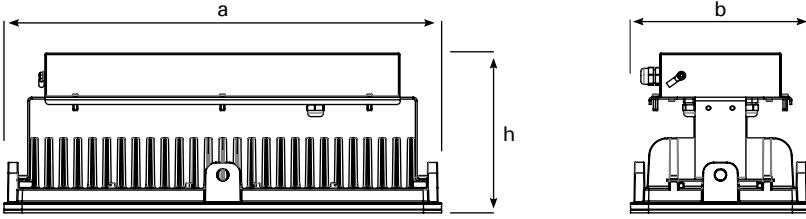

## Ölçüler (mm)

	a	b	h
Tekli Modül	605	249	220
İkili Modül	605	615	220
Üçlü Modül	605	980	220

## Ağırlık (kg)

Tekli Modül	15,4
İkili Modül	41
Üçlü Modül	65

## Tekli Askı Takımı

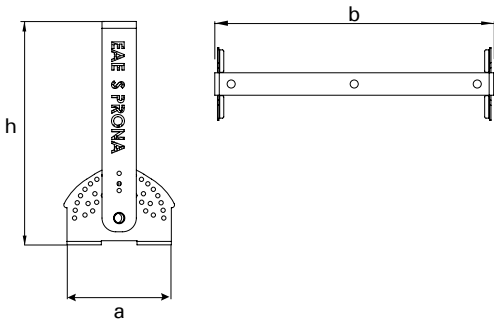

## İkili Askı Takımı

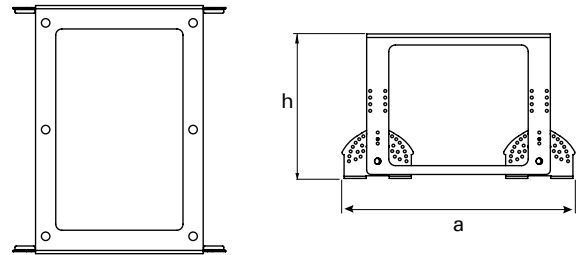

## Üçlü Askı Takımı

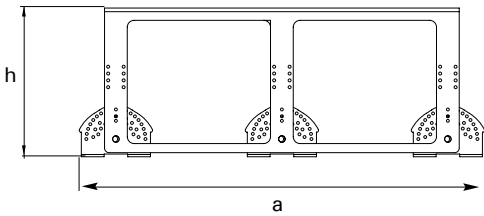

## Ölçüler (mm)

	a	b	h
Tekli Askı Takımı	249	616	345
İkili Askı Takımı	615	-	345
Üçlü Askı Takımı	980	-	345

# SPRONA PLUS



- Tersaneler
- Limanlar
- Gemiler
- Uçak Hangarları

-25°C +50°C

CE

IP66

LED

## Projektör uygulamaları için ideal çözüm

- ✓ Yüksek fiziksel dayanıma sahip alüminyum gövde
- ✓ IP66 koruma & IK08 darbe dayanım sınıfı / Temperli şeffaf cam
- ✓ Özel askı takımı ile liman ve dış mekân uygulamalarında fonksiyonel kullanım
- ✓ -25°C'den +50°C'ye kadar ortam çalışma sıcaklığı



### SPRONA PLUS

851 W – 1051 W  
116026 lm – 149147 lm

OPTİK  
10° / 22° / 57°



**Teknik Çizim**

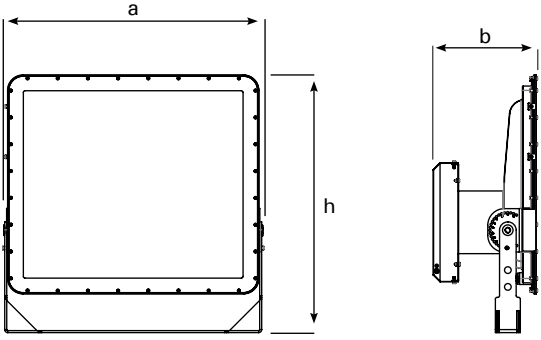

**Ölçüler (mm)**

	a	b	h
Standart	768	228	805

**Ağırlık (kg)**

Standart	45,8
----------	------

# AGILITY



- Tersaneler
- Limanlar
- Gemiler
- Uçak Hangarları
- Yolcu Gemisi Cepheleeri

-25°C +40°C



## Aydınlatmada bir adım önde

- ✓ Ekonomik ve optimum aydınlatma
- ✓ IP66 koruma & IK08 darbe dayanım sınıfı
- ✓ -25°C'den +40°C'ye kadar ortam çalışma sıcaklığı
- ✓ Futbol sahaları, tenis kortları, otoparklar vb. için ideal çözüm
- ✓ Stadyumlara uygun; tekli, ikili ve üçlü kullanım alternatifleri
- ✓ Proje sahalarında kurulum ve bakım kolaylığı
- ✓ Kullanım ihtiyacına göre camlı, camsız, zımparalanmış camlı ve ekstra koruyucu kafes seçenekleri



### AGILITY Tekli Modül

62 W – 130 W  
7400 lm – 18000 lm



### AGILITY İkili Modül

257 W  
30000 lm



### AGILITY Üçlü Modül

385 W  
45000 lm

**Teknik Çizim | Tekli Modül**

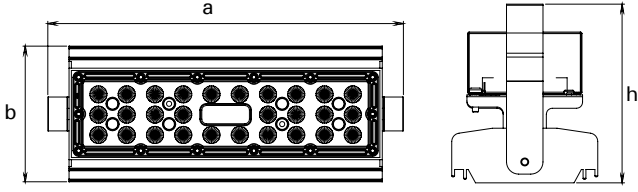

**Teknik Çizim | İkili Modül**

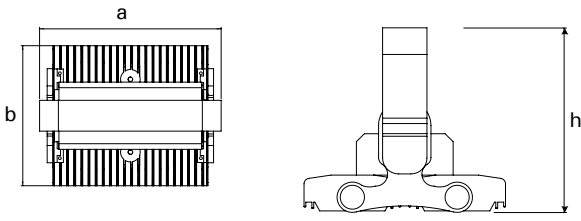

**Teknik Çizim | Üçlü Modül**

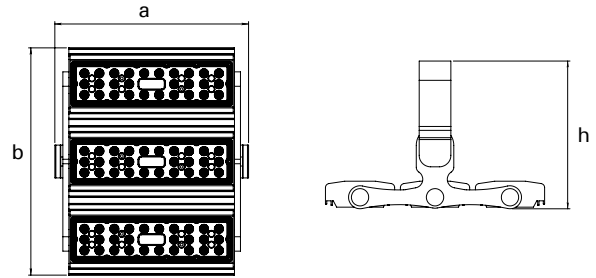

**Ölçüler (mm)**

	a	b	h
Tekli Modül	314	120	147
İkili Modül	324	250	232
Üçlü Modül	324	380	257

**Ağırlık (kg)**

Tekli Modül	2,8
İkili Modül	4,5
Üçlü Modül	6,7

# ALFA (BEŞ MODÜL)

-20°C +30°C

CE

IP66

LED



■ Stadyum

## Sınırları zorlayın, aydınlatmayı Alfa'ya bırakın

- ✓ IP66 koruma & IK09 darbe dayanım sınıfı / Alüminyum enjeksiyon gövde
- ✓ İsteğe bağlı olarak 5 modüle kadar kullanılabilir
- ✓ Spor alanları için optimize edilmiş teknik özellikler
- ✓ Yüksek verimlilik değeri ve gelişmiş optik tasarım
- ✓ -20°C'den +30°C'ye kadar ortam çalışma sıcaklığı
- ✓ TV çekimi için özel LED ve CRI seçenekleri

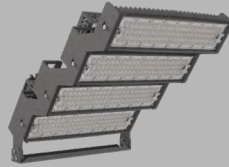

### ALFA İkili Modül

589 W  
59155 lm / 69000 lm

### ALFA Üçlü Modül

884 W  
88733 lm / 103600 lm

### ALFA Dörtlü Modül

1112 W / 1207 W  
113000 lm / 118835 lm

### ALFA Beşli Modül

1392 W / 1475 W  
141256 lm / 147888 lm

## Teknik Çizim

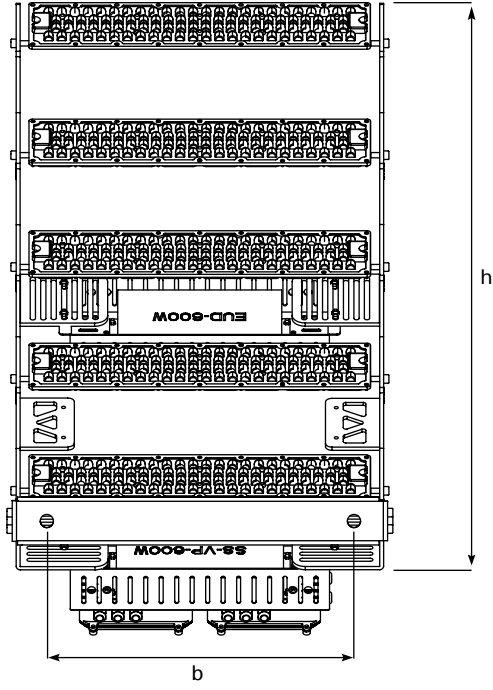

## Teknik Çizim

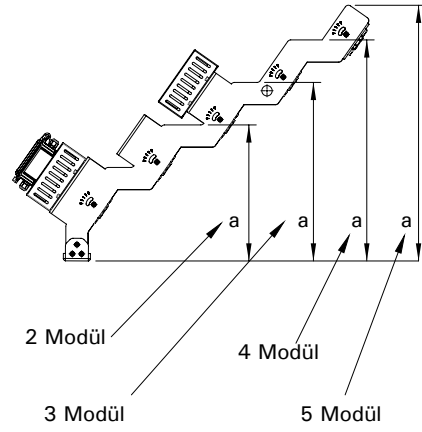
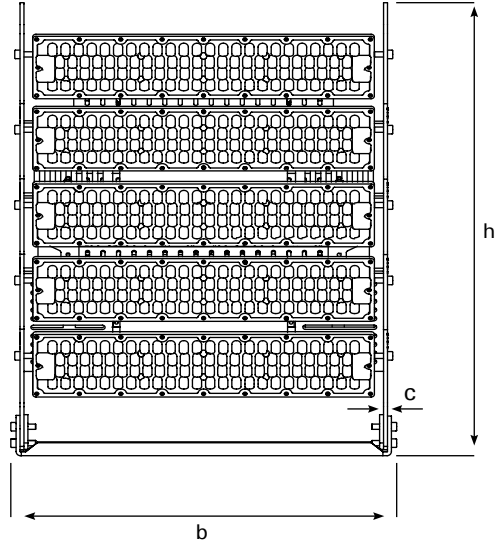

## Ölçüler (mm)

	a	b	h
İkili Modül	572	649	404
Üçlü Modül	572	649	404
Dörtlü Modül	572	649	404
Beşli Modül	572	649	508

# KANOLED

-30°C +50°C



- Petrol Rafinerileri
- Tanker Dolum ve Boşaltım Alanları

## Akaryakıt istasyonları için LED armatür

- ✓ Yanmaya ve patlamaya duyarlı sahalar için özel çözüm
- ✓ IP65 - IP66 koruma & IK07 darbe dayanım sınıfı
- ✓ 250W Metal Halide armatür performansına denktir
- ✓ -30°C'den +50°C'ye kadar ortam çalışma sıcaklığı



### KANOLED V.3 IP65

46 W – 133 W  
6600 lm - 15310 lm

Temperli Cam - Kumlu Cam

**OPTİK**  
Geniş Açılı / 115°  
Through-Wiring



### KANOLED V.3 HE

60 W – 100 W  
9700 lm - 14415 lm

Saydam Cam

## Teknik Çizim

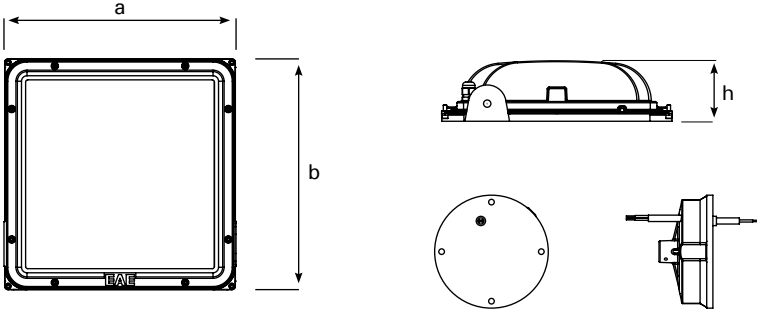

## Ölçüler (mm)

	a	b	h
Standart	336	336	89

## Ağırlık (kg)

Standart	5
----------	---

## Harici ACK Kutusu Standart

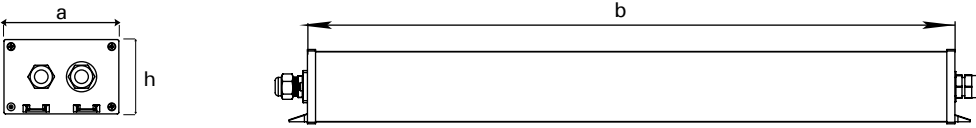

## Harici ACK Kutusu DALI

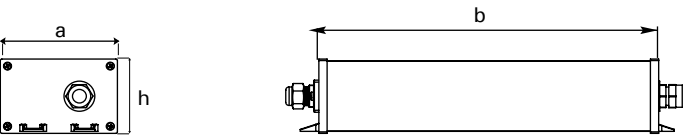

## U Askı Takımı

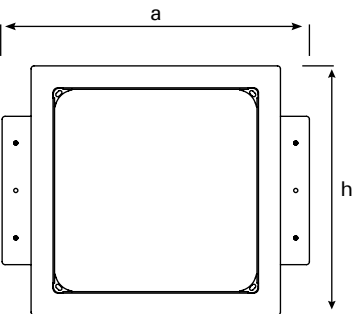

## Ölçüler (mm)

	a	b	h
Harici ACK Kutusu	114	673	74
Harici ACK Kutusu DALI	114	363	74
U Askı Takımı	517,5	92,5	420

# DIMKO

## Sürdürülebilir Enerji Tasarrufu İle Tanışın!

Dimko; ışık kontrol düzeneklerinde, zaman rölelerinin kısma/artırma kontrolünde sinyal üretici olarak kullanılmaktadır. Modül, kullanıcının zaman ve aydınlatma seviyesini ayarlanabilmesini sağlayan bir EAE Aydınlatma kontrol çözümüdür.



### DIMKO SENARYOSU

Yaz ve kış aylarına göre 7 farklı senaryo ile sistem açılış ve kapanış saatleri ayarlanabilmektedir.

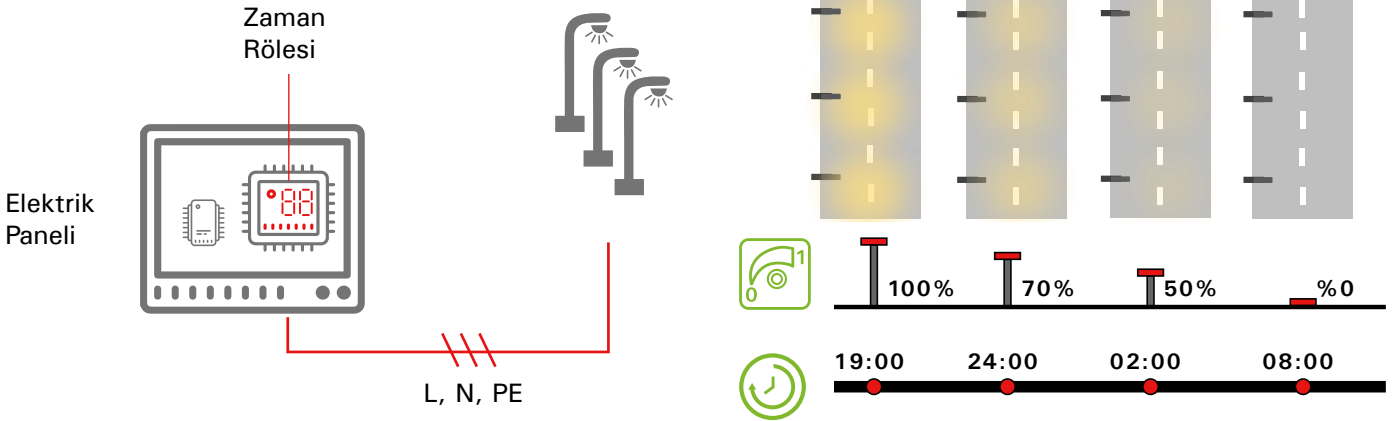

### DIMKO ile uyumlu ürünler



RA

RA 2

RA 3

ARKTOS



## Hızlı, Kolay ve Hesaplı...

**%81**  
%81' e ulaşan enerji tasarrufu.

  
Ekosisteme zarar vermeyen dimleme sistemi.



  
Bakım masrafı gerektirmez.

**%55 ÜZERİ**  
Aydınlatma harcamalarında %55'i aşan tasarruf.



### Kurulum Avantajı

Pahalı kanal kazılarına ihtiyaç duymadan kurulum.



### Verimli Zaman Yönetimi

40sn içerisinde programlanabilir.



### Mevcut Alt Yapı ile Kullanım İmkânı

Mevcut armatür ve direklerin değişimini zorunlu kılmaz.



### Kolay Kontrol

Uzman ekibe gerek duymayan kontrol imkânı sunar.



PROLIT



PROLIT PLUS



PROLIT KOMPAKT



PROLIT-M PRM  
V.2

# SL / DL BUSBAR

E-Line DL Busbar Kanal Sistemleri 25-40A enerji ihtiyacı olan bina elektrik tesisatında kullanılır. 16A çıkış fişleri ile 25A çıkış kutularının özellikleri dolayısıyla aydınlatma ve priz devrelerini beslemek üzere tasarlanmıştır.

EAE Busbar Sistemleri dünyadaki son imalat teknolojileri kullanılarak ISO 9001 Standartlarına uygun ve belgeli Kalite Güvence Sistemi ile üretilmektedir. Ürünler IEC 61439-6'ya göre tasarlanmış ve test edilmiştir.



## ÇIKIŞ FİŞLERİ

DL busbar sistemlerinin çıkış fişleri, busbarın yanlış kullanımını engellemek amacıyla farklı kontak sıralarıyla tasarlanmıştır. Tüm fişler sadece bir yönde busbara takılacak şekilde imal edilmektedir. Bu da yanlış faz kullanımını engeller.

## EMNİYET

Çıkış fişlerinin toprak kontaktarı, takılması sırasında önce temas eder, sökülürken ise teması en son kesilir.



## FAZI GÖSTEREN RENKLİ KAPAKLAR

Çıkış fişlerinin kapakları içerisindeki hangi armatürün daha fazlabeslendiğini rahatça görebilmemiz için farklı renklerde faz göstergeleri ile tasarlanmıştır.



## ELINESL (Tek Taraflı İletken)

4 Eklenti Noktası  
Standart 3m Uzunluk  
Standart olarak tekli tarafında toplam 4 adet bağlantı noktası sağlanır.

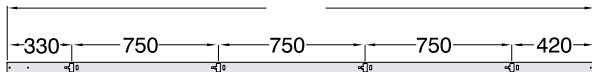
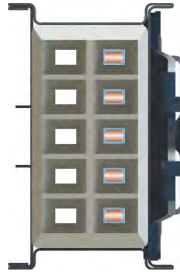

## ELINEDL (Çift Taraflı İletken)

8 Eklenti Noktası  
Standart 3m Uzunluk  
Standart olarak toplam 8 eklenti noktası (her bir tarafta 4 adet) sağlanır.

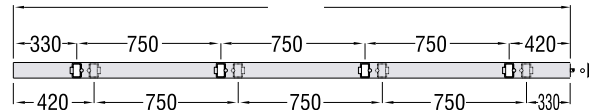
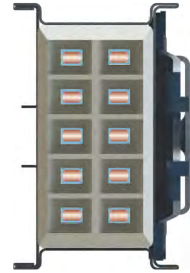

### TAM İZOLASYON

Busbar iletkenleri tam boy alev yürütmeyen izolasyon malzemesi ile kaplanmıştır. Dışardan gelebilecek ağır darbelerde gövde zarar görse dahi, insan güvenliği açısından tam güvence sağlanmıştır.

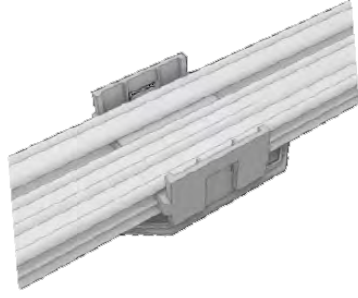

### HIZLI KOLAY VE GÜVENLİ MONTAJ

Tek hareketle, gümüş kaplamalı yaylar mekanik ve elektriksel olarak birbirine temas eder. Vida sıkılarak bağlantı sabitlenir.

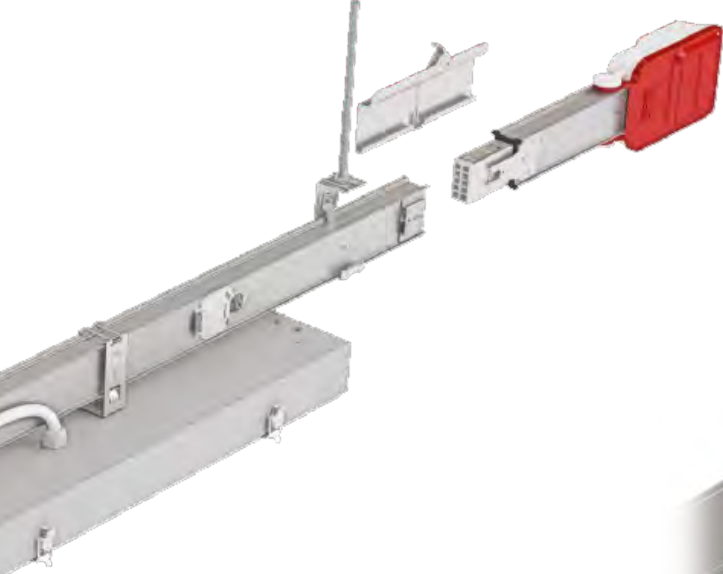

### KALAY KAPLI İLETKENLER VE KONTAK YAPISI

Bakır iletkenler tam boy kalay kaplanarak, bakır oksit oluşumu engellenmiştir. Bu özellik, kontak dirençlerini minimuma indirilmiştir. Çıkış fişlerinin kontakları busbar içerisindeki iletkeni iki yüzeyden sıkıştırır.



### GÜMÜŞ KAPLI EK KONTAKLAR

Busbar ek noktası kontakları ve tüm çıkış ünitelerinin kontakları gümüş kaplıdır. Gümüş kaplama kontak geçiş dirençlerini minimuma indirgeyerek olası azami yüklenmelerde kontakların fazla ısınmalarını engeller.

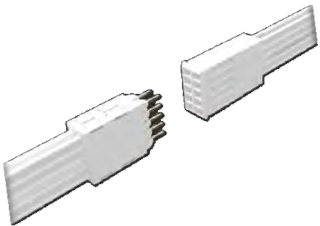



EAE Aydınlatma A.Ş.  
İkitelli OSB Mah. Eski Turgut Özal Cad.  
EAE No: 20, İç Kapı No: Giriş Kat  
Başakşehir / İSTANBUL - TÜRKİYE  
Tel : +90 212 413 21 00 (pbx)  
Faks : +90 212 549 37 90  
[www.eaeaydinlatma.com](http://www.eaeaydinlatma.com)

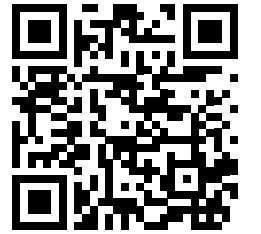

**ışık mühendisliği**

EAE LIGHTING-Brochure **AGUSTRIAL LIGHTING PRODUCT HIGHLIGHTS 2023 - EN** - Uptade Date: 02.11.2023  
EAE. is provided with the right to perform changes deemed necessary without notifying in advance.  
Please contact us for further information about products and details partaking in catalogue.