



INDUSTRY
LIGHTING PRODUCTS



TITLE**Publisher:**

EAE Lighting

Creation and Design:

EAE Lighting

Image Credits:

EAE Lighting

Disclaimer:

We assume no responsibility for the content of references cited in this catalog. The content of the references is the sole responsibility of their publishers.

Copyright:

All contents of this catalog are protected by copyright. The contents may not be stored, reproduced, distributed or used in any other way without the express written permission of EAE Lighting A.Ş.

Contents

SROUND INDUSTRY	8
SROUND	10
REVOLED-X	12
REVERO	14
RERERO NG	16
RERERO SQ	18
HBL	20
HBC	22
HBC - EXPROOF	24
EX LINE MINI	26
EX FOR MINI	28
CUSHIDO	30
PROLIT - EXPROOF	32
PROLIT KOMPAKT	34
PROLIT	36
PROLIT PLUS	38
PROLIT PLUS APRON	40
PROLIT EFFECT	42
MFL	44
VALERIA	46

RA 1-2-3	48
HORUS 1-2	50
OSIRIS	52
ARKTOS NG	54
INFINOO	56
M-LINE	60
GALIS MEGA	62
GALIS	64
YPB BATWING	66
LINA NG	68
TORNADO	70
COZAR	72
YPL NG	74
GPRONA	76
SPRONA	78
SPRONA PLUS	80
AGILITY	82
ALFA	84
KANOLED	86

EAE Lighting

As EAE Lighting, our adventure of innovation and passion that began in 1983 continues unabated. Thanks to the knowledge and experience of the past 40 years, we have made a name for ourselves with our highbay luminaires that set the standards in the sector, while combining the same understanding of quality with aesthetics and functionality in our decorative products. We work with dedication in our modern production facilities, focusing on innovation at every step of our ongoing experience. Designed and developed by our R&D department, our products are meticulously tested in our laboratories, helping us to maintain the high standards of quality and durability that are synonymous with EAE Lighting. Thanks to these standards, our long-lasting products bring us one step closer to our goal of a greener world with less waste, less energy consumption and less use of natural resources.



1983
Established

%90 **Domestic** approved
supplier approval



33,6 Million €
R&D Investments



362
Number of employees



4,4 Million US Dollars
Infrastructure Investments,



4344
(Person x Hour) Occupational
Health and Safety Training,



2.
Turkey Exporters Assembly
(TIM)



15966
(Person x Hour) Total training
duration



2860 GWh
Capacity of Renewable Ener-
gy (GES)



40
Number of countries of
export



911 Tonne
Recycled Waste Amount



%91,33
Rate of customer satisfaction



2.3 Million US Dollars
Renewable Energy (GES)
Investments,



1629 m3
Capacity of Rain Water Storage



1046
(Person X Hour) Sustainability
and Decarbonisation Training



Business Areas



Heavy Industry Oil&Gas

- Petrochemical
- Refinery
- Offshore
- Mining



Automotive Iron&Steel-Glass

- Automotive and Supply Industries
- Glass Factory
- Iron & Steel- Bloomeries



Power Plants

- Nuclear Power Plants
- Steam Power Plants
- Combined Cycle Plants
- HES, JES, GES



Factories Manufacturing Plants

- Textile
- Machinery-Metal
- Plastic
- Food Inc
- Medicine



Railways & Tunnels

- Metro Tunnels
- Highway Tunnels
- Railway Tunnels
- Train Stations



Data Centers

- GSM & Telecom Companies
- Co Hosting Service Providers
- Financial Institutions
- Public Data Centers
- Edge Data Centers
- Computer Rooms



Healtcares

- Public Hospitals
- Private Hospitals
- Clinics
- Laboratories



Complex Buildings & Towers

- Tower & Skycrapers
- Malls
- Office Buildings
- Hotels
- Residences
- Government Buildings



Sport Complexes

- Stadiums
- Indoor Sport Complexes
- Olympic Complexes



Airports

- Terminal Buildings
- Car Park
- Hanger Buildings
- Service Buildings

Certificate

- ISO 9001: 2015
- ISO 10002: 2018
- ISO 14001: 2015
- ISO 27001: 2013
- ISO 45001: 2018
- ISO 50001: 2018
- ISO 14064-1:2018

- TURKISH ACCREDITATION AGENCY
- DEKRA
- DIALUX PARTNER
- UL SOLUTIONS (DEMKO)

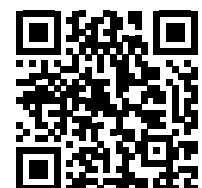

SCAN QR
FOR CERTIFICATES

SROUND INDUSTRY

-35°C +80°C



- Industry Areas
- Cranes

High resistance up to +80°C in industrial environments

- ✓ Ambient operating temperature from -35°C to +80°C
- ✓ IP65 protection & IK09 impact resistance class / Tempered glass
- ✓ Maximum performance in harsh industrial environments
- ✓ External box option up to 10 m cable length
- ✓ Various mounting and fixing options
- ✓ Unique design



SROUND Industry

52 W – 405 W
8629 lm - 52400 lm

OPTIC
Arena / Lowbay

SROUND Mini (TK)

33 W – 88 W
4605 lm - 11367 lm

OPTIC
75° / 103°

SROUND Double

104 W - 810 W
17258 lm - 104800 lm

OPTIC
Arena / Lowbay

Technical Drawing | Industry

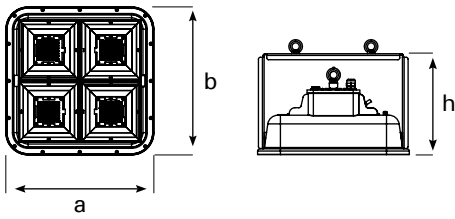

Technical Drawing | Double

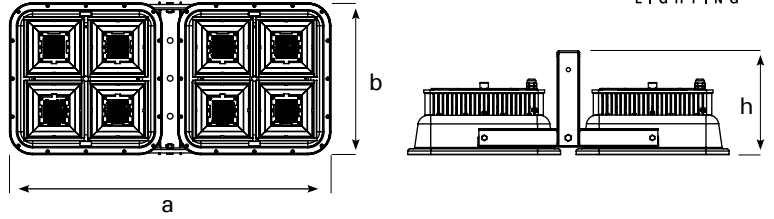

Technical Drawing | Industry Ext.

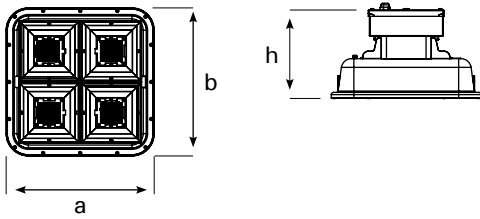

Technical Drawing | Mini (TK)

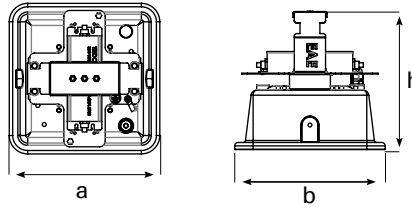

Dimensions (mm)

	a	b	h
Industry	400	400	269
Double	842	400	276
Industry Ext.	400	400	269
Mini (TK)	265	265	244

Weight of Excluding External Box (kg)

Industry	8,3
Double	19,1
Mini (TK)	3,5

External Drive Module

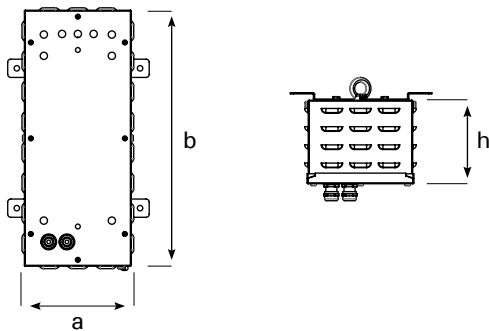

Dimensions (mm)

	a	b	h
External Drive Module	184	429	138

Single U Type Hanger Set

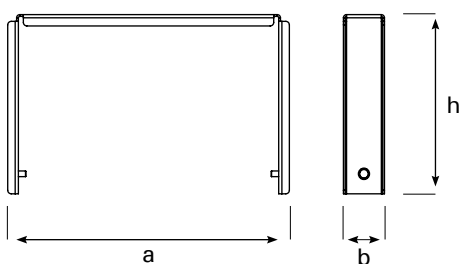

Dimensions (mm)

	a	b	h
External Drive Module	396	59	252

SROUND

-25°C +60°C



- Iron-Steel & Heavy Industry
- Aviation
- Automotive Industry
- Logistics
- Glass and Ceramics
- Machinery and Electronics
- Chemical and Plastic
- Wood and Paper
- Sports Halls

For those who aim high

- ✓ Ultra-high performance high bay LED luminaire
- ✓ IP65 - IP66 protection & IK09 impact resistance class
- ✓ Ambient operating temperature from -25°C to +60°C
- ✓ Variety of suspension kits allowing different mounting types
- ✓ Up to 3 hours emergency kit options / Different type driver options for smart lighting



SROUND IP 65 & IP 66

52 W - 226 W
8629 lm - 32400 lm

OPTIC
Arena / Lowbay /
Extra-Lowbay

SROUND Mini

33 W - 88 W
4605 lm - 11367 lm

OPTIC
75° / 103°

SROUND Crane

68 W - 173 W
10500 lm - 25600 lm

OPTIC
Arena / Lowbay /
Extra-Lowbay

SROUND Red

140 W
8666 lm

OPTIC
Arena

SROUND Chemical

69 W - 137 W
12171 lm - 21506 lm

OPTIC
Arena / Lowbay /
Extra-Lowbay

Technical Drawing | IP65 & IP66 | Crane | Red | Chemical

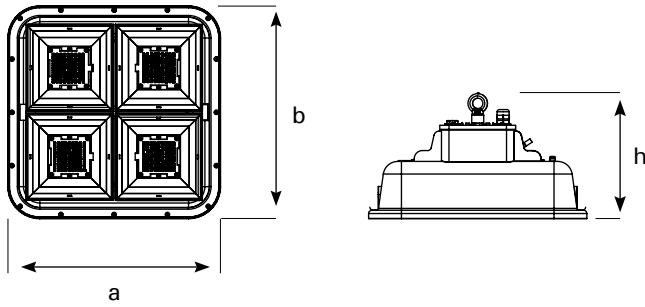

Technical Drawing | Mini (TK)

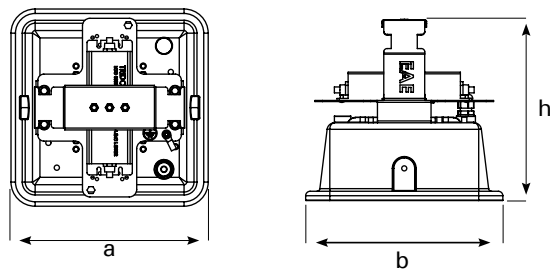

Dimensions (mm)

	a	b	h
IP65 & IP66	400	400	231
Mini	265	265	244
Crane	400	400	231
Red	400	400	231
Chemical	400	400	231

Weight (kg)

IP65 & IP66	7,2
Mini	3,5
Crane	-
Red	7,7
Chemical	7,2

REVOLED-X

-30°C +70°C



- Iron-Steel & Heavy Industry
- Aviation
- Automotive Industry
- Logistics
- Glass and Ceramics
- Machinery and Electronics
- Chemical and Plastic
- Wood and Paper
- Sports Halls



Experience performance at the highest level

- ✓ Ambient operating temperature from -30°C to +70°C
- ✓ IP65 - IP66 protection & IK07 - IK08 - IK09 impact resistance class
- ✓ Mounting types: Cable tray / Busbar / Angled wall / Seismic
- ✓ Up to 3 hours emergency kit / DALI - Wireless control options RF



REVOLED-X

28 W - 128 W
4163 lm - 21078 lm

OPTIC

30°x90° / 30° / 60° / 90° / AS / DA / 25x105°



REVOLED-X HE

26 W - 117 W
4080 lm - 20566 lm

OPTIC

30°x90° / 30° / 60° / 90° / AS / DA / 25x105°



REVOLED-X EVO

67 W - 338 W
9008 lm - 44226 lm

OPTIC

30°x90° / 30° / 60° / 90° / AS / DA / 25x105°



REVOLED-X EVO IP65

67 W - 338 W
9008 lm - 44226 lm

OPTIC

30°x90° / 30° / 60° / 90° / AS / DA / 25x105°



REVOLED-X HOT / HOT PLUS

28 W - 128 W
4294 lm - 21078 lm

OPTIC

30°x90° / 30° / 60° / 90° / AS / DA / 25x105°



REVOLED-X SPORT

28 W - 337 W
4294 lm - 42102 lm

OPTIC

30°x90° / 30° / 60° / 90° / AS / DA / 25x105°



REVOLED-X STERIL

28 W - 128 W
4294 lm - 21078 lm

OPTIC

30°x90° / 30° / 60° / 90° / AS / DA / 25x105°



REVOLED-X FOOD / FOOD COLD

28 W - 128 W
4294 lm - 21078 lm

OPTIC

30°x90° / 30° / 60° / 90° / AS / DA / 25x105°

Technical Drawing

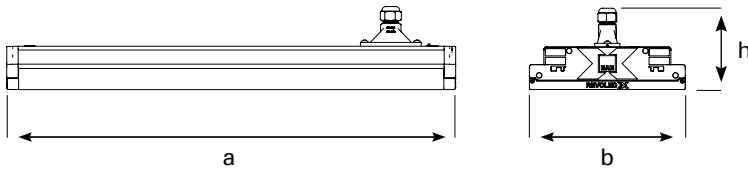

Dimensions (mm)

	a	b	h
Standard	423	209	109
Dali CG (Dual Input)	493	209	109
1,3 hours EMG*	950	209	109
Boxed 1.3 hours EMG*	603	209	135

Weight (kg)

Standard	3,24
Dali CG (Dual Input)	3,77
1,3 hours EMG*	7,26
Boxed 1.3 hours EMG*	7

Busbar Hanger Set (SL / DL)

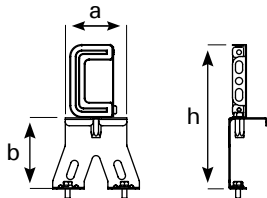

Cable Tray Hanger Set

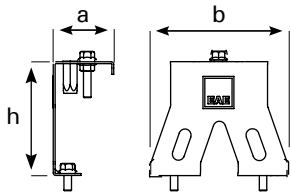

Angular Hanger Set

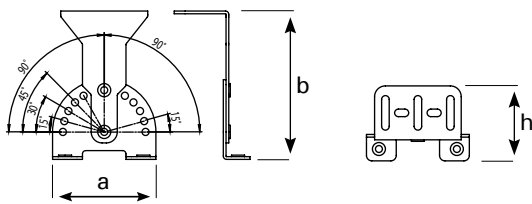

Seismic Hanger Set

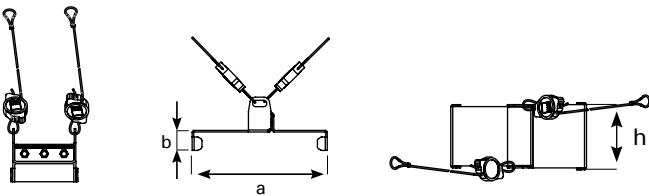

Dimensions (mm)

	a	b	h
Busbar Hanger Set (SL/DL)	78	90	182,5
Double Busbar Hanger Set	182,6	-	90
Cable Tray Hanger Set	48	110	90
Double Tray Hanger Set	358,60	-	90

Double Busbar Hanger Set (SL/DL)

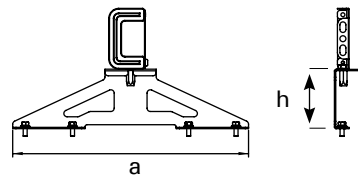

Double Tray Hanger Set

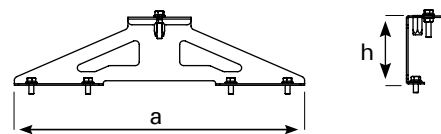

90° Busbar Hanger Set (SL/DL)

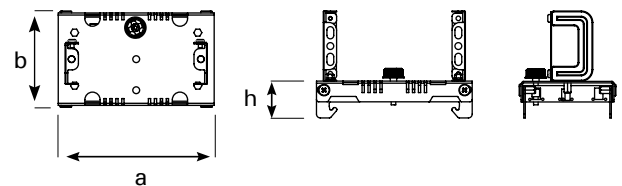

90° Cable Tray Hanger Set

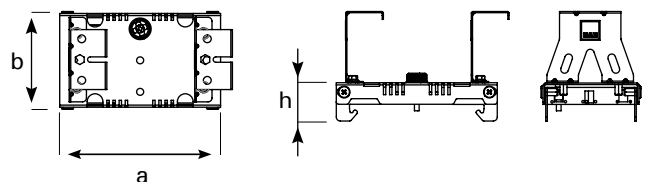

Dimensions (mm)

	a	b	h
Angular Hanger Set	95	135	69,5
90° Busbar Hanger Set (SL/DL)	205	122	48
Seismic Hanger Set	171,88	25,30	75
90° Cable Tray Hanger Set	205	122	48

REVERO

-20°C +40°C



- Industrial Plants
- Aviation and Airports
- Logistics
- Sports Halls

Maximum comfort in lighting

- ✓ LED luminaire with high ceiling
- ✓ IP65 protection & IK05 impact resistance class / Aluminum injection housing
- ✓ Optical options: transparent diffuser / opal diffuser / microprismatic diffuser
- ✓ Ambient operating temperature from -20°C to +40°C
- ✓ Up to 3 hours emergency kit options / Different type driver options for smart lighting



REVERO

70 W - 149 W
9294 lm - 22400 lm

Microprismatic Diffuser /
Opal Diffuser /
Transparent Diffuser

Technical Drawing

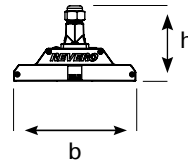
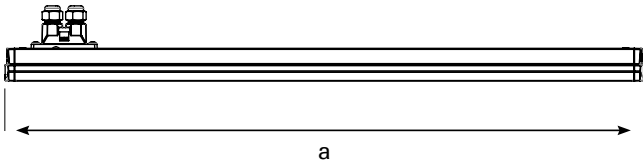

Dimensions (mm)

	a	b	h
Standard	773	148	92

Weight (kg)

Standard	1,9
----------	-----

Busbar Hanger Set (SL / DL)

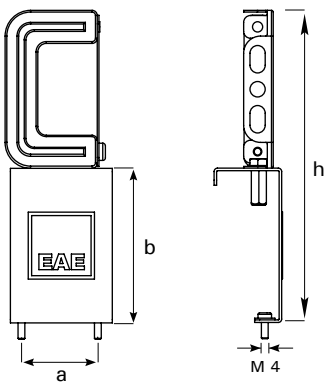

Cable Tray Hanger Set

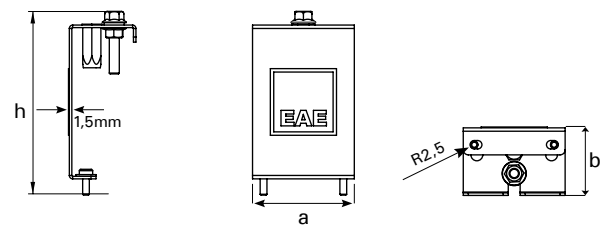

Angular Hanger Set

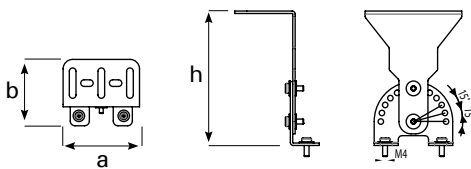

Dimensions (mm)

	a	b	h
Busbar Hanger Set (SL/DL)	45	90	182
Cable Tray Hanger Set	60	40	107
Angular Hanger Set	47	70	109,5

RERERO NG

-20°C +35°C



- Enclosed Warehouses
- Factories and Workshops
- Sports Halls
- Service Stations
- Commercial Buildings

Optimal lighting quality, minimal costs

- ✔ IP64 protection and IK08 shockproof class / Light weight housing design
- ✔ High energy savings for enterprises
- ✔ Easy maintenance thanks to advanced design
- ✔ Ambient operating temperature from -20°C to +35°C
- ✔ Can be mounted on busbar or cable tray

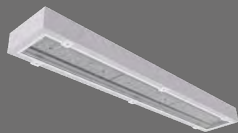

RERERO NG

50 W - 115 W
6579 lm - 16321 lm

Tempered Glass



RERERO NG

70 W - 150 W
8600 lm - 18000 lm

Tempered Sanded Glass

Technical Drawing

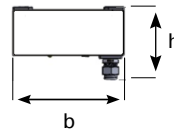
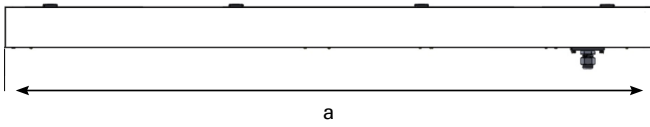

Dimensions (mm)

	a	b	h
Standard	770	154	96,8

Weight (kg)

Standard	6,5
----------	-----

Busbar Hanger Set (SL / DL)

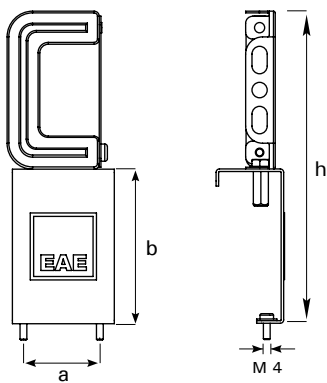

Cable Tray Hanger Set

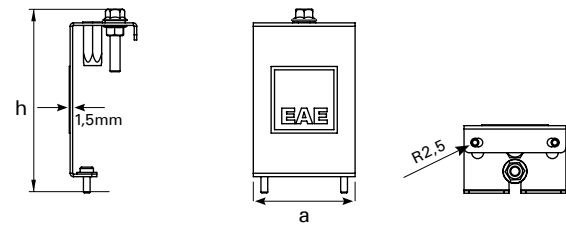

Angular Hanger Set

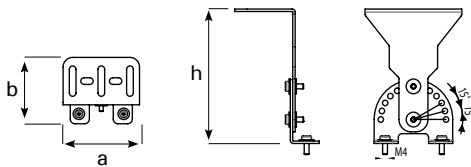

Dimensions (mm)

	a	b	h
Busbar Hanger Set (SL/DL)	45	90	182
Cable Tray Hanger Set	60	40	107
Angular Hanger Set	47	70	109,5

RERERO SQ

-20°C +50°C



- Logistics
- Automotive
- Machinery and Electronics
- Airport
- Glass and Ceramics
- Chemical and Plastic
- Wood and Ceramics

Specially designed for industrial environments

- ✓ Cost effective high ceiling luminaire
- ✓ IP64 protection & IK07 impact resistance class
- ✓ Ambient operating temperature from -20°C to +50°C
- ✓ Up to 3 Hours emergency kit options / DALI Control

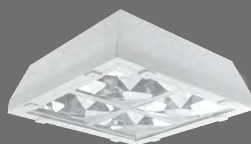

RERERO SQ

70 W – 133 W
11598 lm - 19938 lm

OPTIC
Glass

Technical Drawing

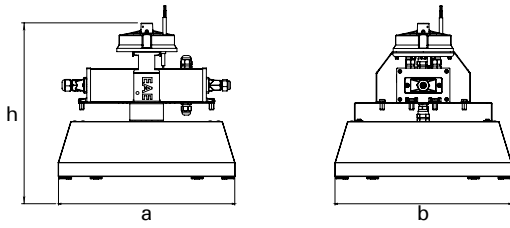

Dimensions (mm)

	a x b	h
Standard	378,5	244

Busbar Hanger Set (SL / DL)

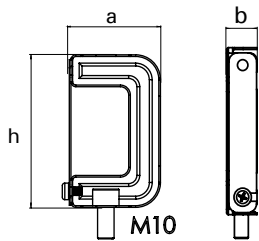

Eye Bolt Hanger Set

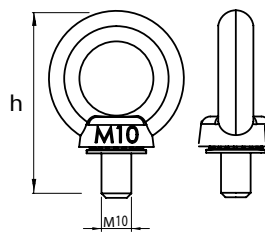

Cable Tray Hanger Set

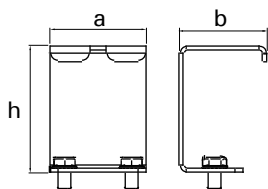

Dimensions (mm)

	a	b	h
Busbar Hanger Set (SL / DL)	55	17	92
Eye Bolt Hanger Set	-	-	62,5
Cable Tray Hanger Set	53	50	102,5



- Industrial Plants
- Aviation and Airports
- Logistics
- Sports Halls

Optimized lighting performance for industrial plants

- ✓ High performance high bay LED luminaire
- ✓ IP65 - IP66 protection & IK10 impact resistance class / Aluminum injection housing and silk screened glass
- ✓ Ambient operating temperature from -30°C to +65°C
- ✓ Sensor option to provide smart lighting control
- ✓ Suitable luminaire for indoor and outdoor areas.
- ✓ Up to 3 hours emergency kit options / Different type driver options for smart lighting



HBL IP65 Lens

88 W – 182 W
11200 lm – 27418 lm

OPTIC
55° / 90°

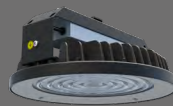

HBL IP66 Lens

65 W – 261 W
9295 lm – 41314 lm

OPTIC
55° / 90°



HBL IP66 Lens + Glass

65 W – 253 W
8700 lm – 36400 lm

OPTIC
55° / 90°



HBL PRJ TK

167 W – 253 W
22596 lm – 36400 lm

OPTIC
55° / 90°

IP65 Lens

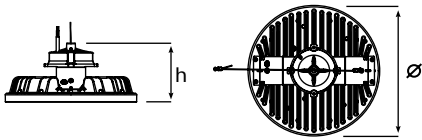

IP66 Lens + Glass

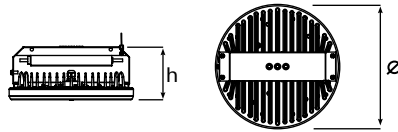

IP66 Lens

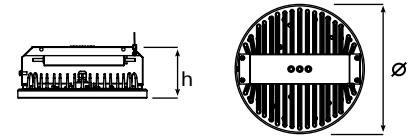

Dimensions (mm)

	Ø x h	
IP65 Lens	315	147
IP66 Lens + Glass	315	135
IP66 Lens	315	127

Weight (kg)

IP65 Lens + Glass	4,6
IP66 Lens + Glass	5,5
IP66 Lens	6,5

Dimensions (mm)

	a	b	h
Busbar Hanger Set (SL/DL)	55	17	92
Single Eye Bolt Hanger Set	-	-	50,5
Cable Tray Hanger Set	60	54,5	80
Cable Tray EMG Kit Hanger Set	69	54,5	103
Double Eye Bolt Hanger Set	-	-	50,5
Double Eye Bolt Hanger Set for EMG Luminaires	78	45	59,5
HBL IP65 Eye Bolt Hanger Set	-	-	62,5
HBL IP65 Tray Hanger Set	-	-	103
HBL IP65 Busbar Hanger Set (SL/DL)	-	-	92

Busbar Hanger Set (SL / DL)

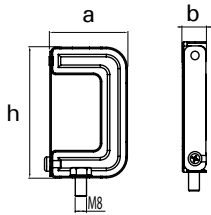

Single Eye Bolt Hanger Set

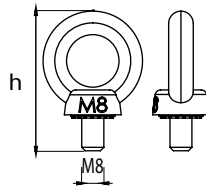

HBL IP65 Eye Bolt Hanger Set

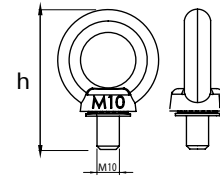

Cable Tray Hanger Set

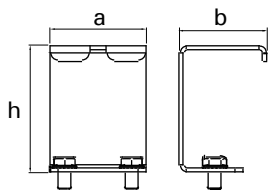

Cable Tray EMG Kit Hanger Set

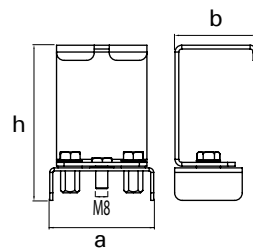

HBL IP65 Busbar Hanger Set (SL / DL)

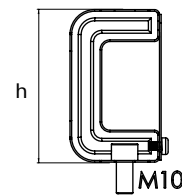

Double Eye Bolt Hanger Set

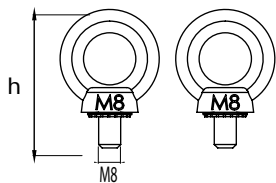

Double Eye Bolt Hanger Set for EMG Luminaires

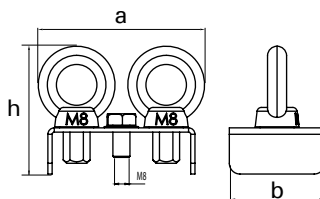

HBL IP65 Cable Tray Hanger Set

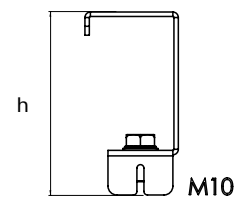

Optional Version With Terminal Box





- Industry Areas
- Sports Halls
- Shopping Centers

Functional and efficient lighting

- ✓ High performance high-ceiling LED fixture
- ✓ IP66 protection & IK05 - IK10 impact resistance class
- ✓ Ambient operation temperature from -20°C to +60°C
- ✓ One-to-one exchange up 400W HIT
- ✓ Option for glass cover
- ✓ Various optics options
- ✓ Variable hanger set options according to using area
- ✓ Sensor option to provide smart lighting control
- ✓ Up to 3 hours emergency kit options / Different type driver options for smart lighting

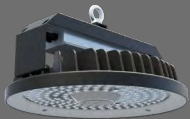

HBC Lens

79 W – 220 W
9860 lm – 26980 lm

OPTIC
60° / 90°



HBC Lens + Glass

75 W – 220 W
8957 lm – 24600 lm

OPTIC
60° / 90°

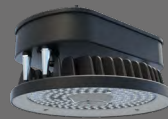

HBC Lens + EMG Kit

79 W – 206 W
9860 lm – 25800 lm

OPTIC
60° / 90°

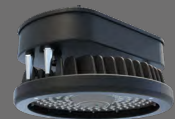

HBC Lens + Glass + EMG Kit

79 W – 155 W
8957 lm – 18616 lm

OPTIC
60° / 90°

Technical Drawing | Lens

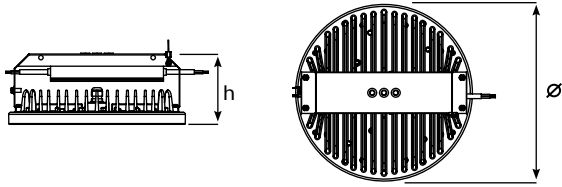

Technical Drawing | Lens + EMG Kit Module

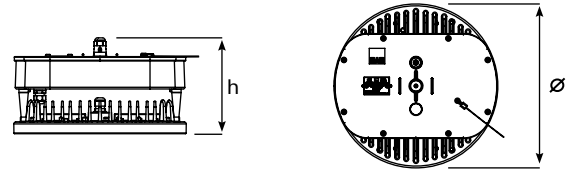

Dimensions (mm)

	Ø x h
Lens	315 x 127
Lens + EMG Kit Module	315 x 162

Weight (kg)

Lens	4
Lens + EMG Kit Module	6

Busbar Hanger Set (SL / DL)

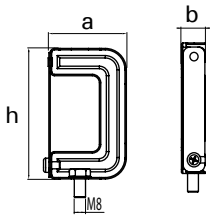

Single Eye Bolt Hanger Set

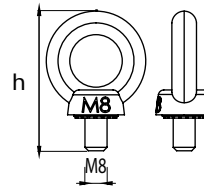

Cable Tray Hanger Set

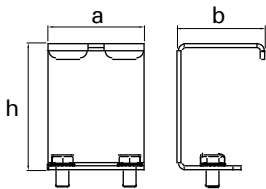

Cable Tray EMG Luminaire Hanger Set

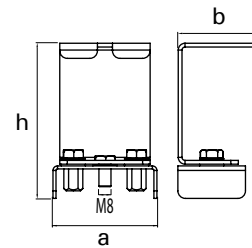

Double Eye Bolt Hanger Set

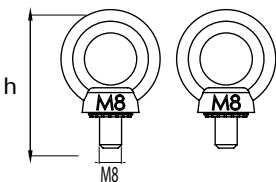

Double Eye Bolt EMG Luminaire Hanger Set

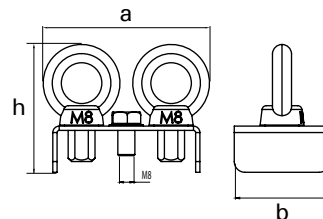

Dimensions (mm)

	a	b	h
Busbar Hanger Set (SL/DL)	55	17	92
Single Eye Bolt Hanger Set	-	-	50,5
Cable Tray Hanger Set	60	54,5	80
Cable Tray EMG Luminaire Hanger Set	69	54,5	103
Double Eye Bolt Hanger Set	-	-	50,5
Double Eye Bolt Hanger Set for EMG Luminaire	78	45	59,5

HBC

EXPROOF ZONE-1 / ZONE-2

-30°C +55°C



- Oil Refineries
- Paint and Melamine
- Production Facilities
- Petrochemicals and Chemistry
- Petrol Stations

The reliable option for Ex-Proof areas

- ✓ Suitable design for environmental conditions containing hazardous substances
- ✓ IP66 protection & IK10 impact resistance class / Tempered screen printing glass
- ✓ Ambient operation temperature from -30°C to +55°C
- ✓ Zone classification in plants where explosive and flammable substances are produced: Zone 1 / 21 - 2 / 22 Group / Category:II / 2.1 2GD Protection class: db / mb / eb / tb Zone 2.21 3G/2D protection class nR / tb
- ✓ High efficiency, low power consumption
- ✓ Up to 3 hours emergency kit options / Different type driver options for smart lighting

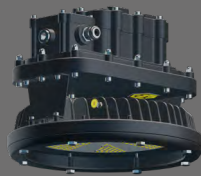

HBC EXPROOF-ZONE 1.21

70 W – 130 W
8400 lm – 15000 lm

OPTIC
110°



HBC EXPROOF-ZONE 2.21

75 W – 197 W
8000 lm – 20100 lm

OPTIC
50° / 80°

Dimensions (mm)

	∅ x h
Zone 1	311 x 251
Zone 2	315 x 201

Technical Drawing | Zone 1

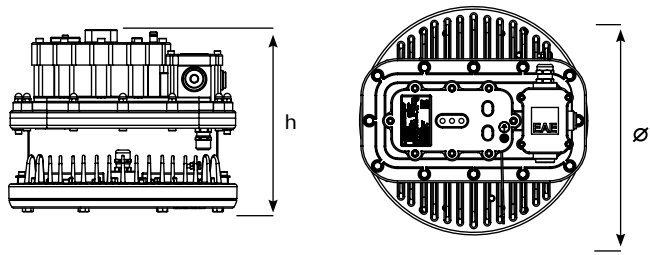

Weight (kg)

Zone 1	10,1
Zone 2	6,8

Technical Drawing | Zone 2

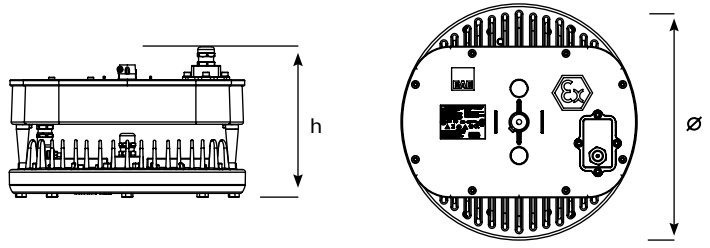

Cable Tray

Single Hanger Set Ex Zone 1

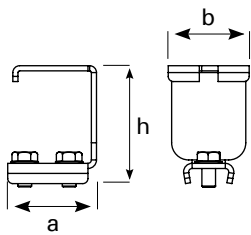

Angular Hanger Set Wall

Mounted Ex Zone 1

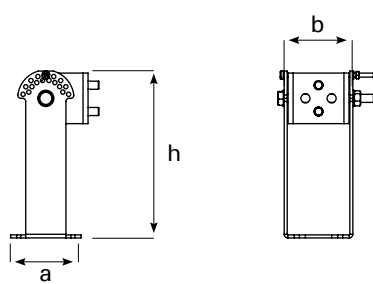

Eye Bolt Hanger Set Ex Zone 1

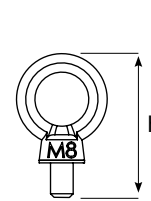

Pipe Fitting Hanger Set Ex Zone 1

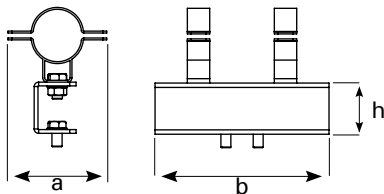

Surface Mounted Hanger Set

Ex Zone 1

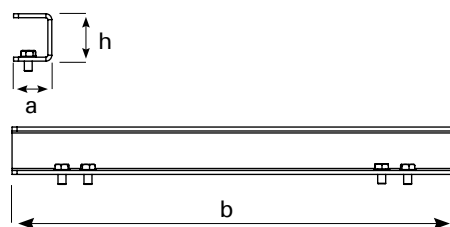

Flush Ceiling Wall Hanger Set

Ex Zone 1

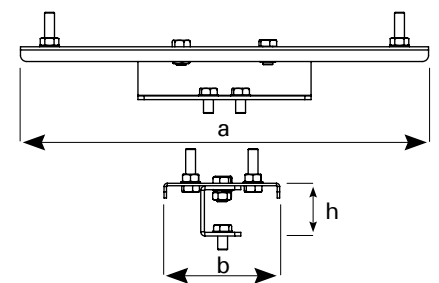

Cable Tray

Double Hanger Set Ex Zone 2

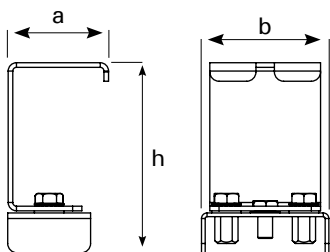

Busbar Hanger Set (SL/DL)

Ex Zone 2

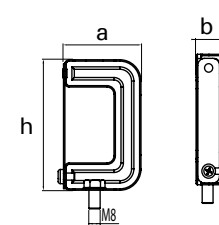

Eye Bolt Double Hanger Set

Ex Zone 2

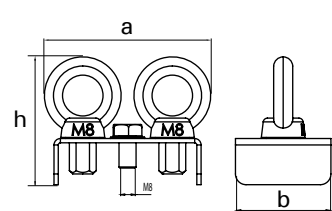

Dimensions (mm)

	a	b	h
Cable Tray Single Hanger Set Ex Zone 1	52	47	69
Angular Hanger Set Wall Mounted Ex Zone 1	70,1	68,2	162
Eye Bolt Hanger Set Ex Zone 1	-	-	50,5
Pipe Fitting Hanger Set Ex Zone 1	77,8	140	41
Surface Mounted Hanger Set Ex Zone 1	39,3	446	48

	a	b	h
Flush Ceiling Wall Hanger Set Ex Zone 1	330	94	43
Cable Tray Double Hanger Set Ex Zone 2	54,5	69	103
Busbar Hanger Set (SL/DL) Ex Zone 2	55	17	92
Eye Bolt Double Hanger Set Ex Zone 2	78	45	59,5

EX-LINE

MINI ZONE-1

-40°C +45°C

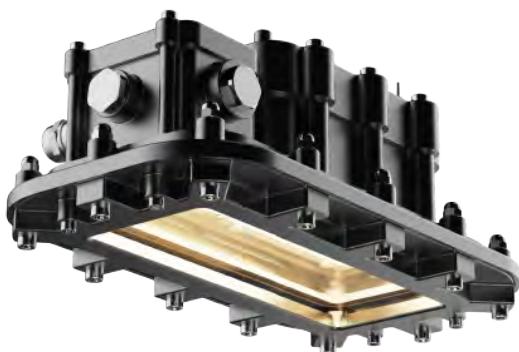

- Oil Refineries
- Paint and Melamine Production Facilities
- Production Facilities
- Petrochemicals and Chemistry
- Petrol Stations

High quality Ex-Proof luminaire with robust housing

- ✓ Zone classification in plants where explosive and flammable substances are produced:
Zone 1 / 21 - 2 / 22 Group / Category:II / 2GD
Protection class: db / tb / eb
- ✓ IP66 protection & IK10 impact resistance class / Aluminum injection housing
- ✓ Ambient operating temperature from -40°C to +45°C
- ✓ DALI control option

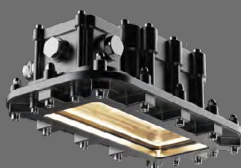

EX-LINE MINI

20 W – 57 W
2695 lm – 7089 lm

OPTIC
Wide Angle

Technical Drawing

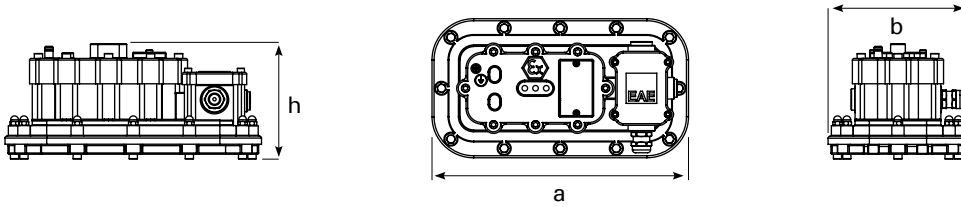

Dimensions (mm)

	a	b	h
Mini Zone 1	311	171	141

Weight (kg)

Standard	5,2
----------	-----

Surface Mounted Hanger Set



Pipe Fitting Hanger Set

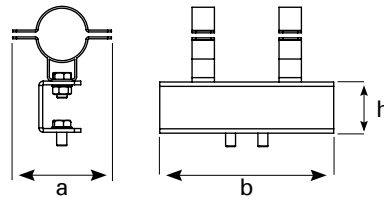

Angular Hanger Set Wall Mounted

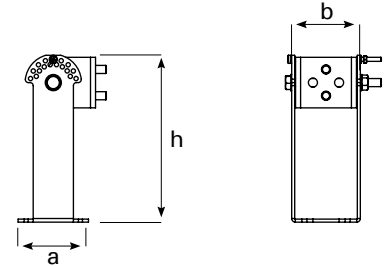

Cable Tray Double Hanger Set

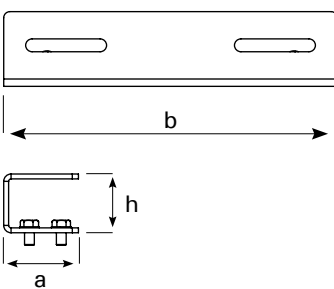

Cable Tray Hanger Set

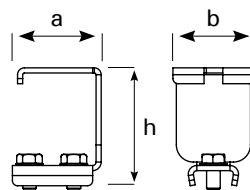

Eye Bolt Hanger Set

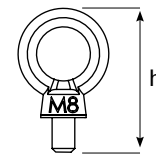

Dimensions (mm)

	a	b	h
Surface Mounted Hanger Set	39,3	446	48
Pipe Fitting Hanger Set	77,8	140	41
Angular Hanger Set Wall Mounted	70,1	68,2	162
Cable Tray Double Hanger Set	61	270	48
Cable Tray Hanger Set	52	47	69
Eye Bolt Hanger Set	-	-	50,5

EX FOR MINI

-40°C +45°C



High quality Ex-Proof luminaire with robust housing

- Oil Refineries
- Paint and Melamine Production Facilities
- Production Facilities
- Petrochemicals and Chemistry
- Petrol Stations

- ✓ Zone classification in plants where explosive and flammable substances are produced:
Zone 1 / 21 - 2 / 22 Group / Category:II / 2GD
Protection class: db / tb / eb
- ✓ IP66 protection & IK10 impact resistance class /
Aluminum injection housing
- ✓ Ambient operating temperature from -40°C to
+45°C
- ✓ DALI control option



EX-FOR MINI

20 W – 51 W
2300 lm – 5540 lm

OPTIC
Wide Angle

Technical Drawing

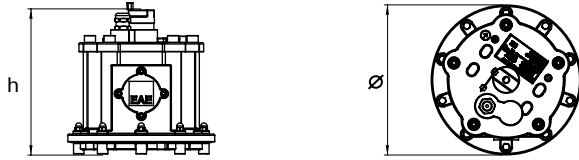

Dimensions (mm)

	Ø x h
Ex-For Mini	225 x 221

Weight (kg)

Ex-For Mini	5,5
-------------	-----

Cable Tray Hanger Set

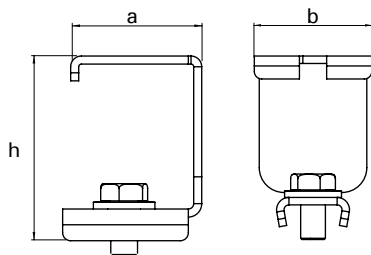

Cable Tray Double Hanger Set

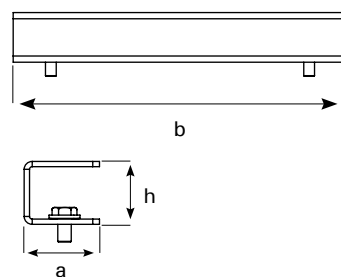

Eye Bolt Hanger Set

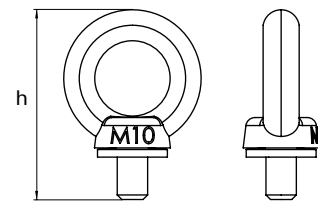

Dimensions (mm)

	a	b	h
Cable Tray Hanger Set	49	47	69
Cable Tray Double Hanger Set	56	310	48
Eye Bolt Hanger Set	-	-	63

CUSHIDO

-25°C +55°C



- Oil Refineries
- Paint and Melamine Production Facilities
- Production Facilities
- Petrochemicals and Chemistry
- Petrol Stations

High performance, durable Ex-Proof luminaire

- ✓ For explosion and combustion sensitive, sensitive areas ideal choice
- ✓ IP66 protection & IK10 impact resistance class / Polycarbonate housing and diffuser
- ✓ Ambient operating temperature from -25°C to +55°C
- ✓ Up to 3 hours emergency kit options / Different type driver options for smart lighting
- ✓ Zone classification generated for installations where explosive and flammable substances are present: Zone 2/22



CUSHIDO

43 W – 71 W
6100 lm – 10100 lm

OPTIC
Wide Angle

Technical Drawing

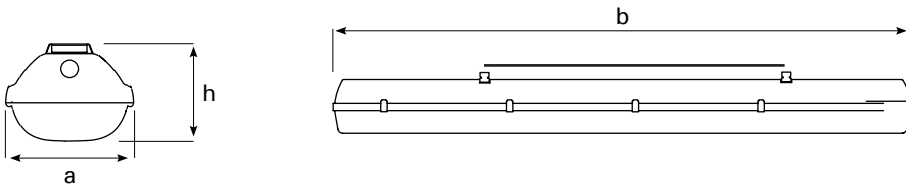

Dimensions (mm)

	a	b	h
120 cm	145	1272	111
150 cm	145	1572	111

Weight (kg)

120 cm	3,4
150 cm	4,4

PROLIT EX-PROOF

-20°C +55°C



- Logistics
- Shipyards
- Tanker Filling and Unloading Areas
- Oil Refineries
- Fuel Ships

Ex-Proof floodlight for harsh environmental conditions

- ✔ Ultra-high-power LED floodlight
- ✔ IP66 protection & IK09 impact resistance class / Tempered screen printing glass
- ✔ Ambient operating temperature from -20°C to +55°C
- ✔ Special housing designed for harsh environments
- ✔ Wide lumen package and flexible optical options
- ✔ DALI control option
- ✔ Zone classification generated for installations where explosive and flammable substances are present: Zone 2/22 Group / Category: II / 3GD Protection class: ec / tc



PROLIT EX-PROOF

102 W – 206 W
13716 lm – 25760 lm

OPTIC
22° / 32° / 57° / 99° / AS



PROLIT KOMPAKT EX-PROOF

40 W – 96 W
5100 lm – 11366 lm

OPTIC
16° / 90° / AS / DA

Technical Drawing | Exproof

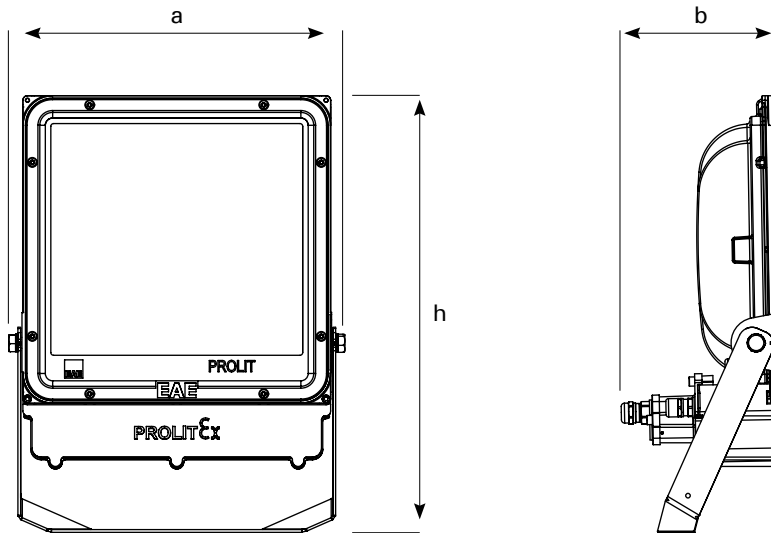

Technical Drawing | Kompakt Exproof

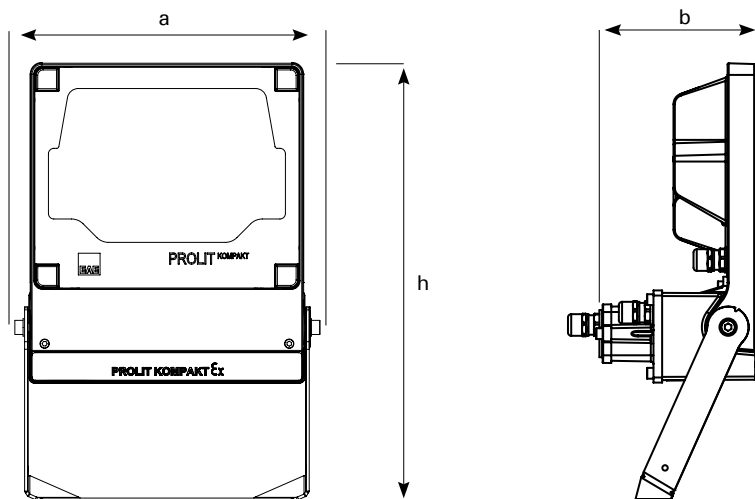

Dimensions (mm)

	a	b	h
Prolit Ex-Proof	279	173	476
Prolit Kompakt Ex-Proof	281	149	404

Weight (kg)

Prolit Ex-Proof	7,1
Prolit Kompakt Ex-Proof	5,3

PROLIT KOMPAKT

-30°C +55°C



- Logistics
- Shipyards
- Tanker Filling and Unloading Areas
- Oil Refineries
- Onshore Facilities
- Ship and Shipbuilding
- Aircraft Hangars

Compact lighting solution for many applications

- ✓ Efficient alternative to conventional lighting floodlights
- ✓ Ambient operating temperature from -30°C to +55°C
- ✓ IP66 protection & IK08 impact resistance class
- ✓ Save up to 53% or 70% energy with DALI control
- ✓ Special housing adaptations for Tunnel / Marine Prolit Tunnel / Prolit Ship.



PROLIT KOMPAKT V3 / NG

30 W – 124 W
4000 lm – 14400 lm

OPTIC
16° / 18° / 22° / 23° / 27° /
35° / 46° / 52° / 60° / 90° /
98° / 99° / AS /
Sport lens / 0 Tilt

Technical Drawing

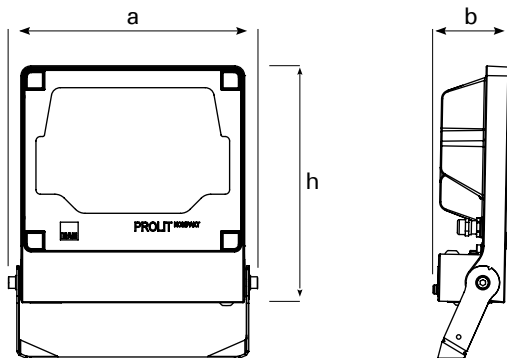

Dimensions (mm)

	a	b	h
Standard	280	76	330

Weight (kg)

Standard	3,6
----------	-----

Pipe Fitting Hanger Set

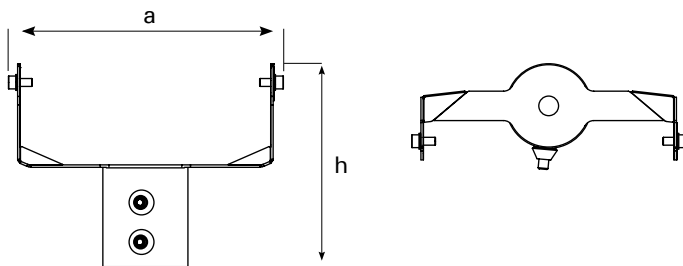

Dimensions (mm)

	a	h
Pipe Fitting Hanger Set	277	205

Optional Version With Terminal Box

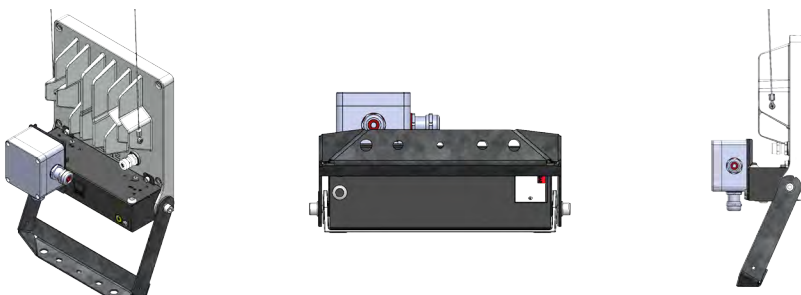

PROLIT

-30°C +60°C



- Open Spaces
- Ports
- Sports Halls
- Industrial Plants
- Parking Lots
- Advertising Boards
- Building Facades

Ultra-high performance luminaire for floodlight applications

- ✓ Ultra high power LED floodlight
- ✓ IP66 protection & IK09 impact resistance class
- ✓ Ambient operating temperature from -30°C to +60°C
- ✓ Excellent floodlight for 1:1 replacement up to 400 W HIT
- ✓ Energy savings of up to from 65% to 80%.
- ✓ Special housing adaptation for tunnel / ship applications
- ✓ DALI / DIMKO / 1-10V / RF control options



PROLIT NG / MP

94 W – 230 W
12494 lm – 28306 lm

OPTIC

10° / 13° / 16° / 18° / 22° /
23° / 27° / 30° / 46° / 52°
/ 57° / 60° / 90° / 98° /
99° / AS / Sport lens / 0 Tilt



PROLIT SHIP

101 W – 206 W
13400 lm – 25800 lm

OPTIC

10° / 13° / 16° / 18° / 22° /
23° / 27° / 30° / 46° / 52°
/ 57° / 60° / 90° / 98° /
99° / AS / Sport lens / 0 Tilt

Technical Drawing

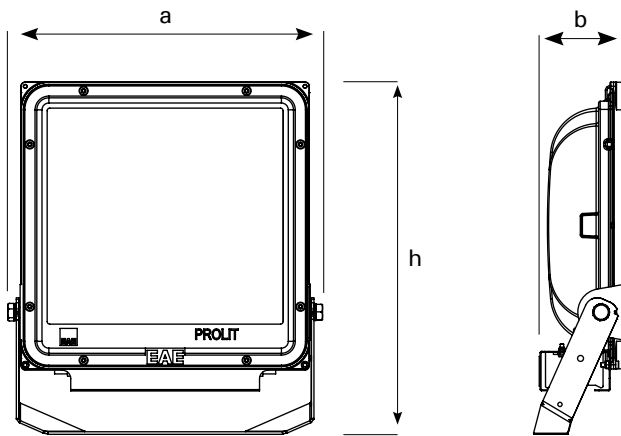

Dimensions (mm)

	a	b	h
Standard	336	95	412

Weight (kg)

Standard	7,1
----------	-----

Pipe Fitting Hanger Set

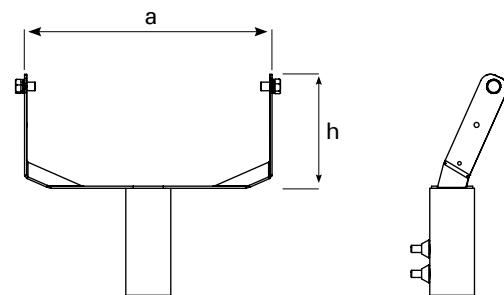

Dimensions (mm)

	a	h
Pipe Fitting Hanger Set	345	310
Single Point Hanger Set	345	345

Single Point Hanger Set

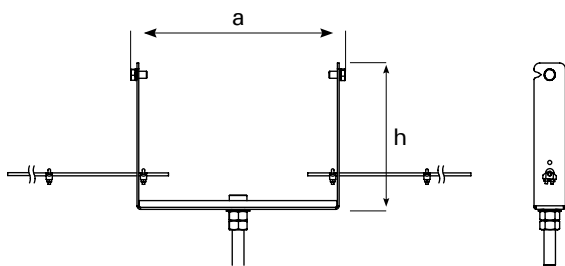

PROLIT PLUS



- General Open Spaces
- Ports
- Sports Halls
- Industrial Plants
- Parking Lots
- Building Facades

-30°C +60°C



Lighting solution in large areas

- ✓ Special housing adaptation for Port / Apron / Tunnel
- ✓ IP66 protection & IK09 impact resistance class / Tempered screen printing glass
- ✓ Ambient operation temperature from -30°C to +60°C
- ✓ DALI / 1-10V / DIMKO / RF control options



PROLIT PLUS

195 W – 435 W
25300 lm – 58706 lm

OPTIC

16° / 18° / 23° / 27° / 30° / 35° / 45° /
46° / 52° / 60° / 90° / 98° / AS /
Sport lens / 0 Tilt

Technical Drawing

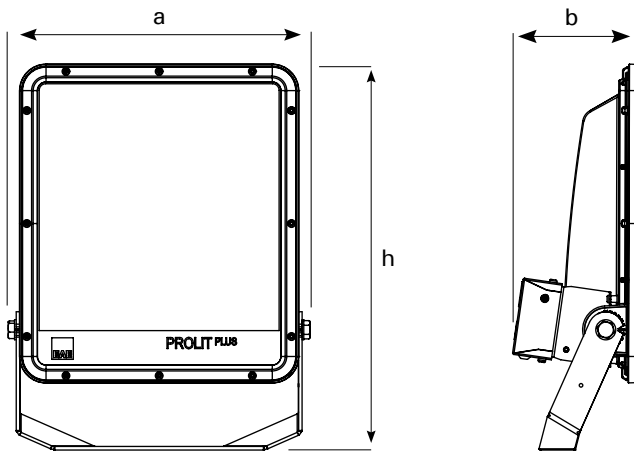

Dimensions (mm)

	a	b	h
Standard	424	174	537



Weight (kg)

Standard	11,5
----------	------

Dimensions (mm)

	a	b	h
Corner Hanger Set	422	-	331
Easy Assembly Bracket	399	-	-
4 Piece Single Angle Hanger Set	870	-	-
Adjustable Suspension Set 1x	-	-	286
Double Pipe Hanger Set	-	-	600
Vertical Pipe Hanger Set	220	-	160
Adjustable Suspension Set	690	78	

Corner Hanger Set

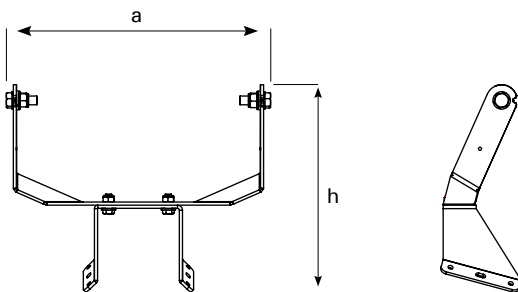

4 Piece Single Angle Hanger Set

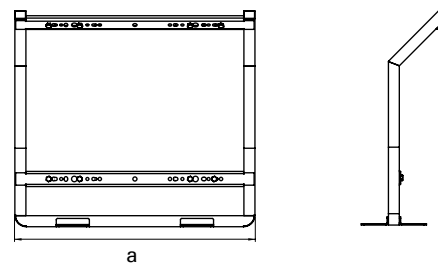

Easy Assembly Bracket

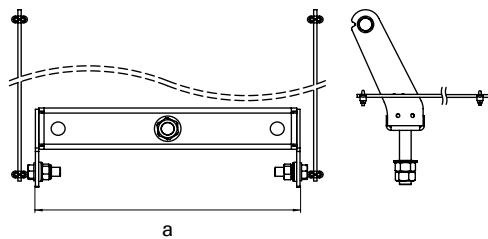

Double Pipe Hanger Set

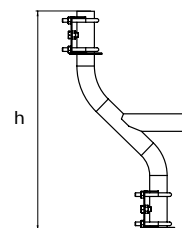

Adjustable Suspension Set 1x

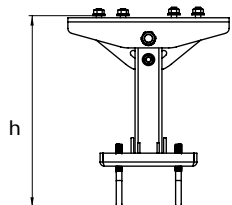

Vertical Pipe Hanger Set

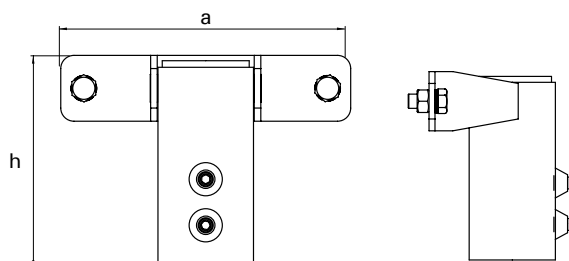

Adjustable Suspension Set

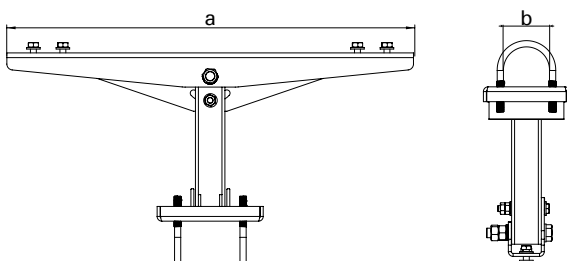

PROLIT

Plus Apron



■ Airports

-30°C +50°C



Designed for airport runways

- ✓ Metallized plastic reflector
- ✓ IP66 protection & IK10 impact resistance class
- ✓ Ambient operation temperature from -30°C to +50°C
- ✓ Asymmetric optics specially developed for airports
- ✓ DALI / 1-10V / DIMKO / RF control options



PROLIT Plus Apron Single

211 W – 354 W
24481 lm – 41391 lm

OPTIC
Special Lens for Apron Areas



PROLIT Plus Apron Double

422 W – 708 W
49682 lm – 82782 lm

OPTIC
Special Lens for Apron Areas

Technical Drawing

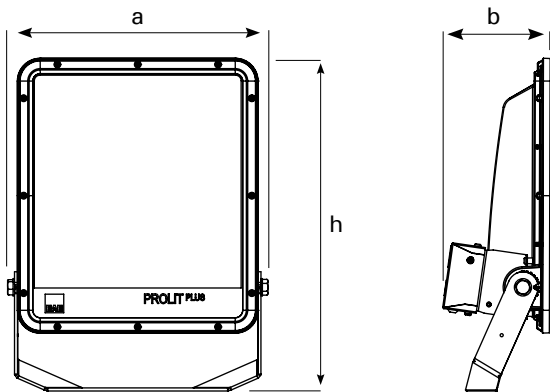

Dimensions (mm)

	a	b	h
Single	424	537	171
Double	824	525	173

Weight (kg)

Single	12,5
Double	25

Technical Drawing

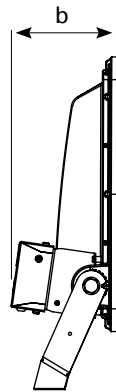
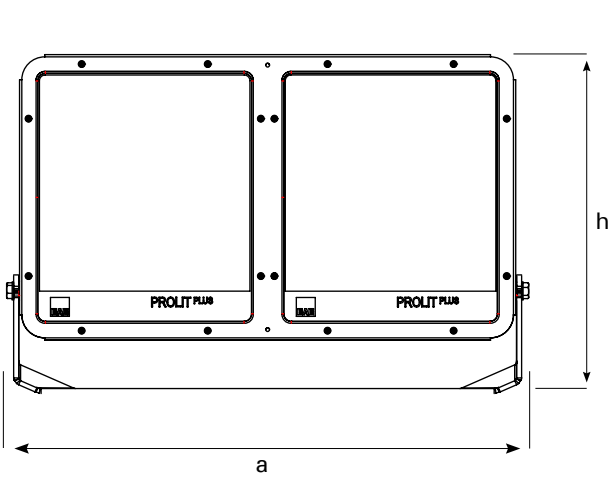

PROLIT EFFECT

-30°C +55°C



- Shipyards
- Ports
- Ship and Shipbuilding
- Aircraft Hangars
- Square Lighting

The lightest and most efficient floodlight on the global market

- ✓ Durable facade and area luminaire
- ✓ IP66 protection & IK09 impact resistance class / Tempered and screen printed glass diffuser
- ✓ Ambient operating temperature from -30°C to +55°C
- ✓ DALI control option



PROLIT EFFECT

420 W – 770 W
56421 lm – 102371 lm

OPTIC

10° / 13° / 16° / 18° / 22° /
23° / 27° / 30° / 46° / 54° /
57° / 60° / 90° / 98°
SP / AS / 0 Tilt

Technical Drawing

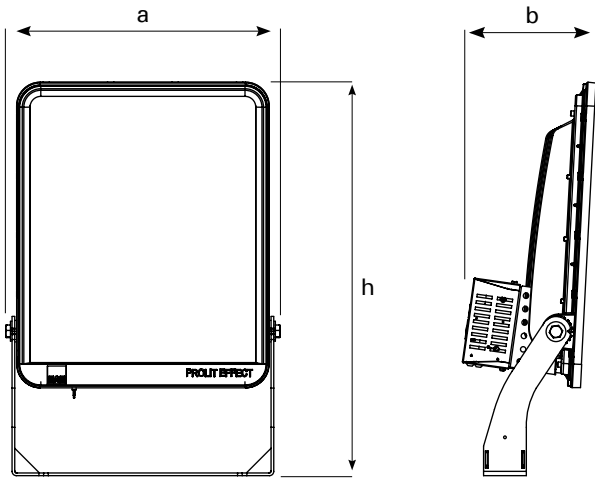

Dimensions (mm)

	a	b	h
Single	512	270	731

Weight (kg)

Standard	18,8
----------	------

Hanger Set

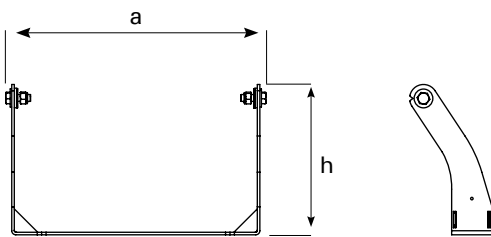

Dimensions (mm)

	a	h
Hanger Set	295	487

MFL

-30°C +55°C



Extra innovative floodlight designed for marine applications

- ✓ High-performance LED luminaire
- ✓ Special coating resistant to marine paints
- ✓ IP66 protection & IK10 impact resistance class
- ✓ Ambient operating temperature from -30°C to +55°C
- ✓ DALI control option

- Shipyards
- Ports
- Ship
- Passenger Ship Facades



MFL

65 W – 164 W
9295 lm – 24364 lm

Mid Power LED

OPTIC
55° / 90°

Technical Drawing

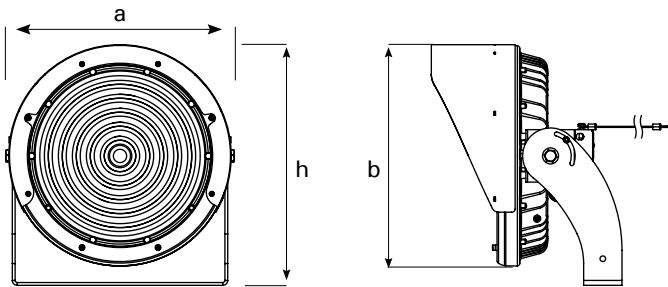

Dimensions (mm)

	a	b	h
Single	327	316	344

Weight (kg)

Standard	8,1
----------	-----

Hanger Set

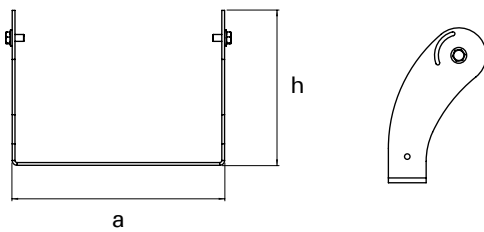

Dimensions (mm)

	a	h
Hanger Set	308	225

VALERIA

-20°C +40°C



Perfect solution for lighting needs of large areas

- ✓ The ideal solution for outdoor lighting
- ✓ IP66 protection & IK08 impact resistance class
- ✓ Ambient operating temperature from -20°C to +40°C
- ✓ DALI control option

- Open Spaces
- Ports
- Sports Halls
- Industrial Plants
- Parking Lots
- Advertising Boards
- Building Facades



VALERIA

45 W – 292 W
5616 lm - 37938 lm

Tempered Glass - Glazed Glass

OPTIC
60° / 90°

Technical Drawing

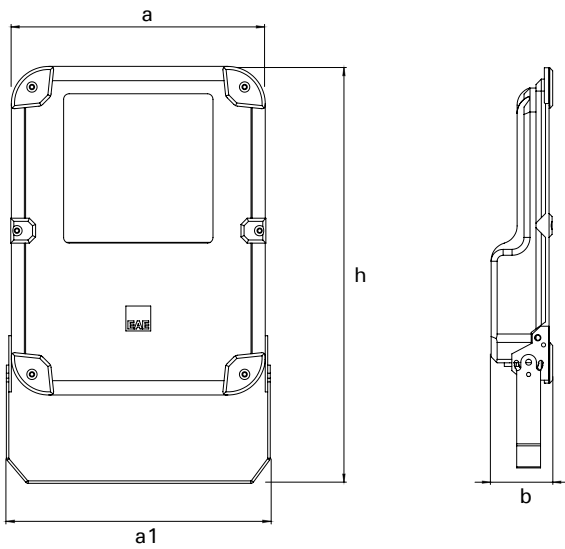

Dimensions (mm)

	a	a1	b	h
Standard	205	212	50	335

Weight (kg)

Standard	6,7
----------	-----

RA / RA2 / RA3

-40°C +60°C



- City and Residential Streets
- Bridges
- Bicycle and Pedestrian Paths
- Squares
- Parking Lots
- Perimeter Lighting
- Roads and Highways

Powerful street and road lighting

- ✓ Powerful LED mast top luminaire
- ✓ IP66 protection & IK09 impact resistance class
- ✓ Ambient operating temperature from -40°C to +60°C
- ✓ Optional insulation protect class (Class I & Class II)
- ✓ Intelligent lighting control system via DIMKO, NEMA, Zhaga and RF



RA

25 W – 58 W
3558 lm – 7962 lm

OPTIC

100° / 110° / Wide Angle / Extra Wide Angle

RF Wireless and DALI / 1-10V
Dimko / Nema / Zhaga control options



RA 2

30 W – 116 W
3637 lm – 16906 lm

OPTIC

100° / 110° / Wide Angle / Extra Wide Angle

RF Wireless and DALI / 1-10V
Dimko / Nema / Zhaga control options



RA 3

103 W – 218 W
15300 lm – 27700 lm

OPTIC

100° / 110° / Wide Angle / Extra Wide Angle

RF Wireless and DALI / 1-10V
Dimko / Nema / Zhaga control options

Technical Drawing

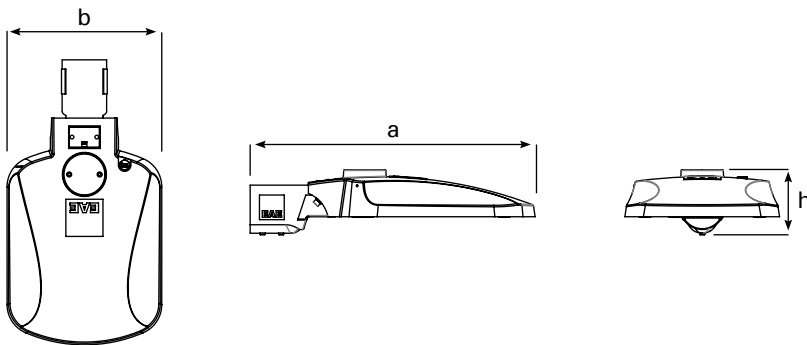

Dimensions (mm)

	a	b	h
Ra	250	460	105
Ra2	310	639	104
Ra3	310	705	104

Weight (kg)

Ra	3,4
Ra2	6,7
Ra3	8,3

HORUS 1-2

-20°C +35°C



- Street and Environment
- Ports
- Highways
- Shipyards
- Open Spaces
- Urban Areas

Modern, highly efficient street and perimeter lighting

- ✓ Highly durable LED luminaire for street lighting
- ✓ High mechanical resistance housing with IP66 and IK08 resistance and tempered transparent glass
- ✓ -20°C to +35°C ambient operating temperature
- ✓ DALI /1-10V + Dimko options
- ✓ Driver and led intervention sections separated



HORUS-1

79 W – 123 W
10200 lm – 13500 lm

Mid Power LED

OPTIC
100°



HORUS-2

117 W – 195 W
15700 lm – 23044 lm

Mid Power LED

OPTIC
100°

Technical Drawing

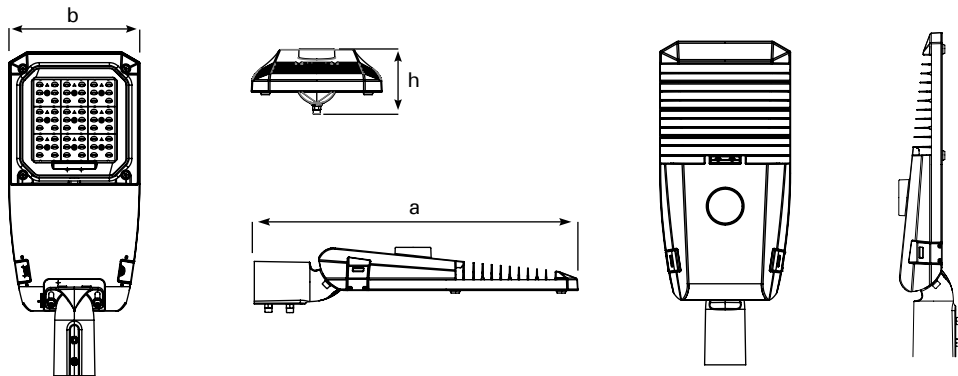

Dimensions (mm)

	a	b	h
Horus 1	601	243	120
Horus 2	721	313	120

Weight (kg)

Horus 1	3,5
Horus 2	5,1

OSIRIS

-20°C +40°C



- Street and Environment
- Ports
- Highways
- Shipyards
- Open Spaces
- Urban Areas

High performance street luminaire

- ✓ Luminaire suitable for M1 and all other road classes
- ✓ IP66 protection & IK09 impact resistance class / Tempered transparent glass
- ✓ Ambient operating temperature from -20°C to +40°C
- ✓ Quick and easy installation
- ✓ High energy savings
- ✓ DALI control option
- ✓ Clamshell driver for easy replacement



OSIRIS

237 W – 375 W
30430 lm – 48352 lm

OPTIC
Mid Power LED
100°

Technical Drawing

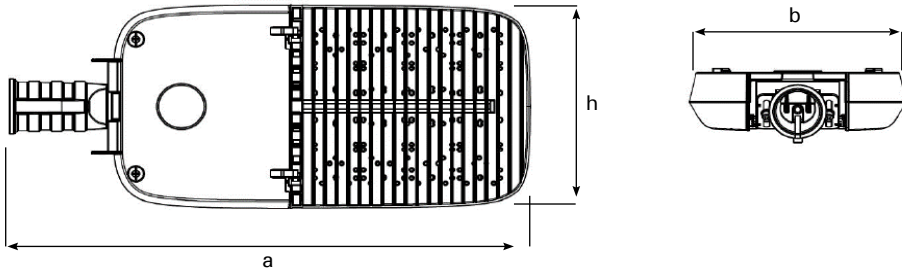

Dimensions (mm)

	a	b	h
Standard	910	320	112

Weight (kg)

Standard	10,5
----------	------

ARKTOS

NG



- Street and Environment
- Ports
- Highways
- Shipyards
- Open Spaces
- Urban Areas

-40°C +50°C



Perimeter lighting with excellent performance

- ✓ Streetlight LED luminaire
- ✓ Aluminium injection monobloc housing
- ✓ Ambient operating temperature from -40°C to +50°C
- ✓ IP66 protection & IK09 impact resistance class / Tempered transparent glass
- ✓ High energy saving and long lasting use
- ✓ Environmentally friendly lighting with zero mercury



ARKTOS

55 W – 142 W
7100 lm – 15656 lm

Mid Power LED

OPTIC
110°

Technical Drawing

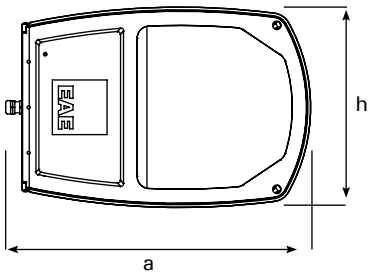

Dimensions (mm)

	a	b	h
Standard	475	92,5	330

Weight (kg)

Standard	6
----------	---



- Logistics
- Data Centers
- Textile
- Retail and Presentation
- Office and Communication
- Education and Science
- Art & Culturer

Endless applications for the perfect lighting experience

- ✓ LED linear duct system: Energy transmission, lighting control and more... All in one solution.
- ✓ IP20 - IP40 - IP64 protection & IK02 impact resistance class
- ✓ Ambient operating temperature from -20°C to +74°C
- ✓ Simple, fast and tool-free installation
- ✓ UGR < 19 option
- ✓ Number of conductors from 5 to 11
- ✓ Aluminium housing



INFINOO IP20 / IP40

20 W – 197 W
3200 lm – 25583 lm

OPTIC

30° / 60° / 90° / Asymmetric /
Double Asymmetric

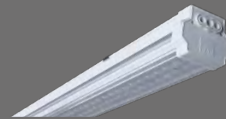

INFINOO IP64

20 W – 197 W
3200 lm – 25583 lm

OPTIC

30° / 60° / 90° / Asymmetric /
Double Asymmetric



INFINOO DUO

93 W – 192 W
15744 lm – 27709 lm

OPTIC

30° / 60° / 90° / Asymmetric /
Double Asymmetric



INFINOO
OPAL IP20 & IP40

36 W – 98 W
4439 lm – 11156 lm

Opal Diffuser



INFINOO
OPAL IP64

25 W – 106 W
2800 lm – 12051 lm

Opal Diffuser



INFINOO
TRACK

Three Phase Track Rail for
INFINOOLINE



INFINOO
SENSOR

Sensor unit
compatible with INIFINOOLINE
channel duct



INFINOO
EXIT

Emergency guidance unit
Suitable for INFINOOLINE
channel duct



INFINOO
COVER

Compatible with
metal or PC covers
INFINOO channel duct.

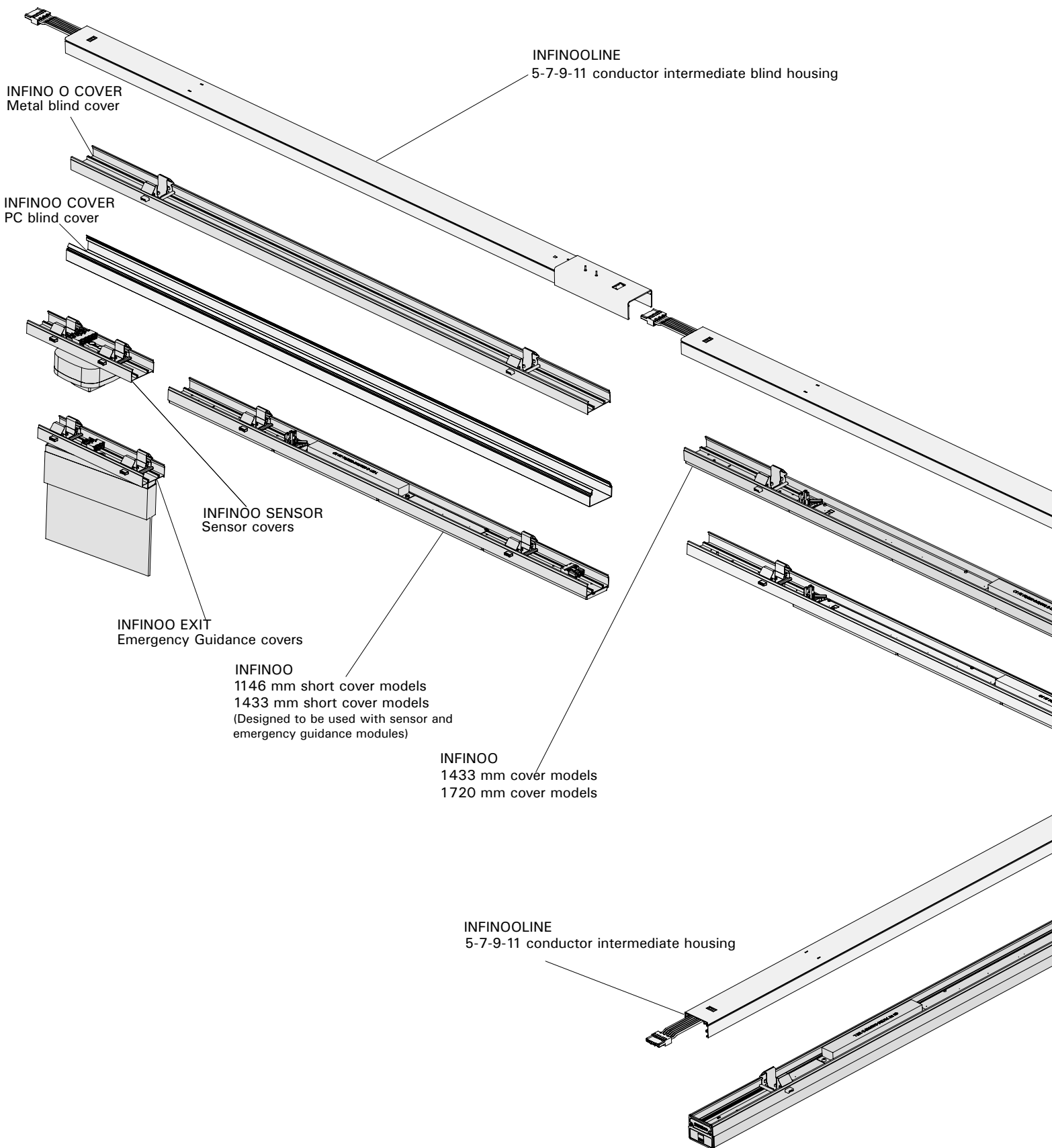

INFINO O COVER
Metal blind cover

INFINOO COVER
PC blind cover

INFINOO SENSOR
Sensor covers

INFINOO EXIT
Emergency Guidance covers

INFINOO
1146 mm short cover models
1433 mm short cover models
(Designed to be used with sensor and
emergency guidance modules)

INFINOO
1433 mm cover models
1720 mm cover models

INFINOOLINE
5-7-9-11 conductor intermediate blind housing

INFINOOLINE
5-7-9-11 conductor intermediate housing

Hanger Set

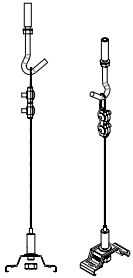

STEEL FIBRE-REINFORCED CONCRETE SUSPENSION SET

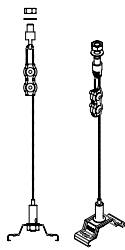

STEEL FIBRE-CABLE TRAY SUSPENSION SET

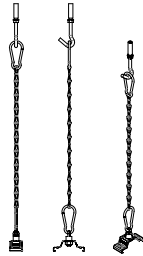

CHAIN CONCRETE SUSPENSION SET



CHAIN CONCRETE CABLE TRAY SUSPENSION SET

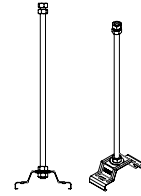

ROD-WIRE CABLE TRAY SUSPENSION SET

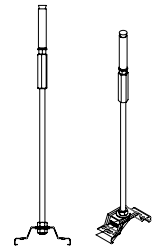

ROD-CONCRETE SUSPENSION SET

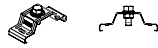

SUPPORT SPRING CABLE TRAY INSTALLATION TOOL

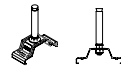

SUPPORT SPRING CONCRETE INSTALLATION TOOL

INFINOOLINE
5-7-9-11 conductive
intermediate housing

INFINO RAY
Three-phase track 1433mm cover models
Three-phase track 1720mm cover models

X turning

T turning

L turning

INFINO DUO

M-LINE

-20°C +40°C



- Logistics
- Education and Science
- Complex
- Shops and Markets
- Office and Administrative Buildings

Cost-effective alternative for endless lighting applications

- ✓ High performance surface-mounted modular lighting LED luminaire
- ✓ IP40 protection & IK02 impact resistance class
- ✓ Ambient operating temperature from -20°C to +40°C
- ✓ Opal diffuser option
- ✓ Surface-mounted modular lighting
- ✓ Different housing sizes according to the area of use
- ✓ Up to 3 hours emergency kit options / Different type driver options for smart lighting



M-LINE

11 W – 75 W
1540 lm – 10240 lm

OPTIC
30° / 60° / 90° /
Double Asymmetric / Batwing

Technical Drawing

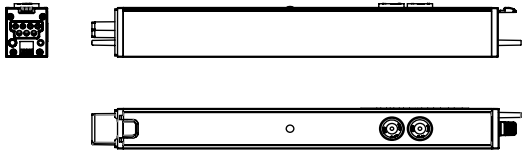

Central Feeder Box Module

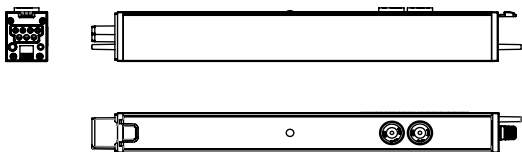

Starting Feeder Module

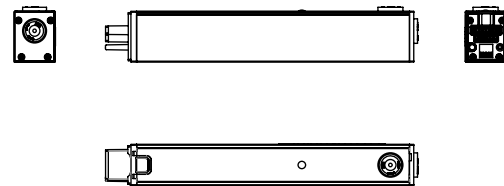

Intermediate Module

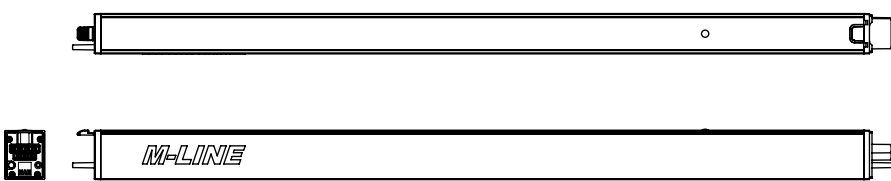

End Closer Module

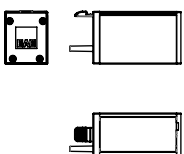

Weight (kg)

Single Module	1,56
Blank Module	1,15
Intermediate Module	1,76
Center Feed Module	0,46
Feeder Module	0,35
Termination Module	0,1

Support Kits

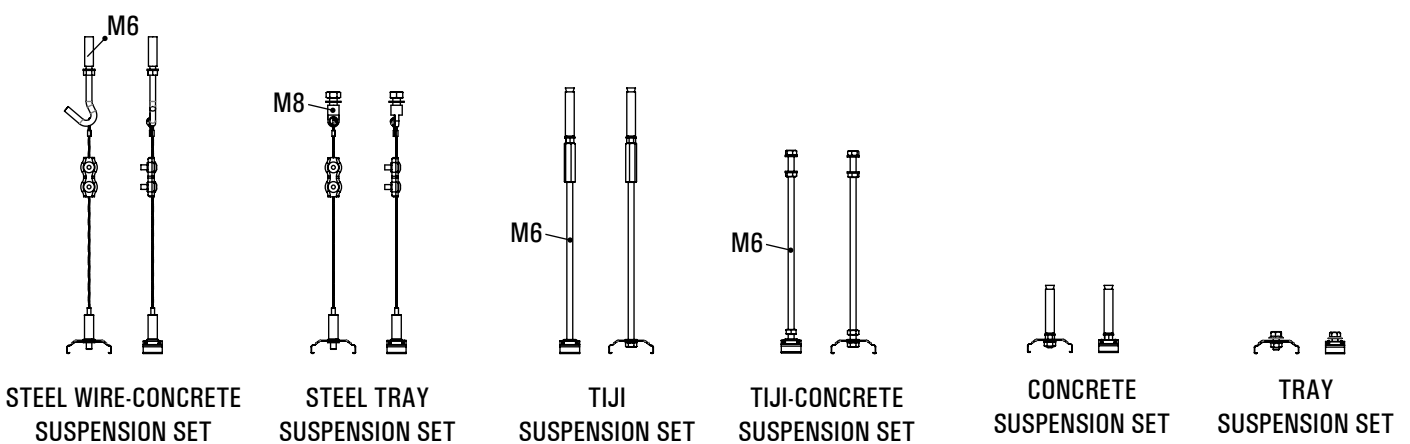

GALIS MEGA

-25°C +40°C



- Logistic Plants
- Education and Science Buildings
- Mixed Buildings
- Shops and Markets
- Office and Administrative Buildings

The ideal solution for flexible use

- ✓ High performance etange LED lighting fixture
- ✓ Maximum energy saving
- ✓ IP65 protection & IK09 impact resistance class / Aluminum extruded housing
- ✓ Ambient operating temperature from -25°C to +40°C
- ✓ Flexible mounting with movable mounting spring
- ✓ Quick and easy electrical connection with cable gland
- ✓ Up to 3 hours emergency kit option / DALI control
- ✓ Normal and Through-Wiring cabling options

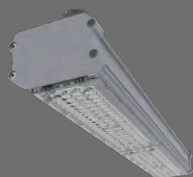

GALIS Mega

25 W – 130 W
3500 lm – 18800 lm

OPTIC

15° / 25° / 40° / 60° / 90° /
Asymmetric Lens

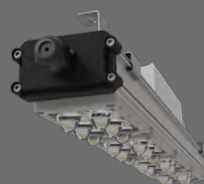

GALIS Mega - Tempered Glass + Lens

25 W – 130 W
3500 lm – 18800 lm

OPTIC

15° / 25° / 40° / 60° / 90°

Technical Drawing | Feeding From Side

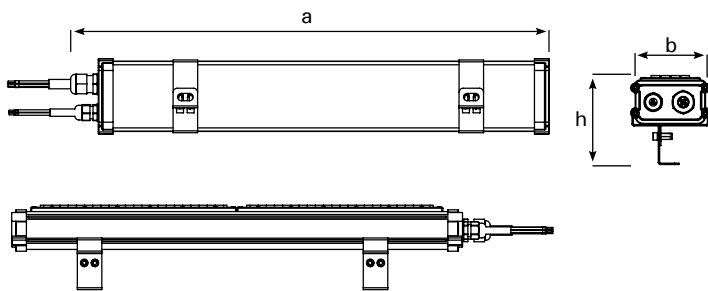

Dimensions (mm)

	a	b	h
Galis Mega Feeding From Side	585	93	107
Galis Mega Feeding From Top	556	93	132

Technical Drawing | Feeding From Top

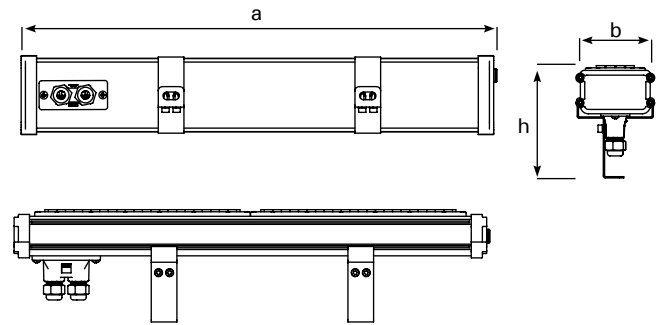

Weight (kg)

Standard	1,7
Standard EMG Kit	2
DALI + EMG Kit	2

Fixed Hanger Set

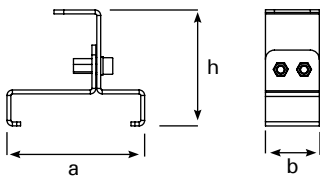

Angular Double Hanger Set

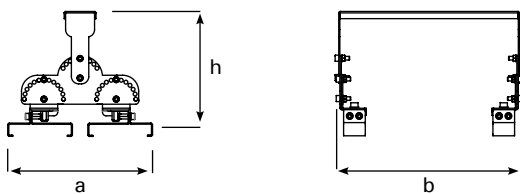

Angular Triple Hanger Set

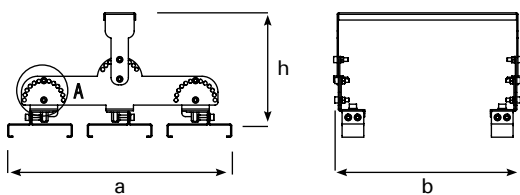

Angular Hanger Set

(Standard or Stainless Steel Version)

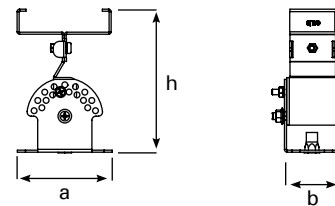

Double Hanger Set

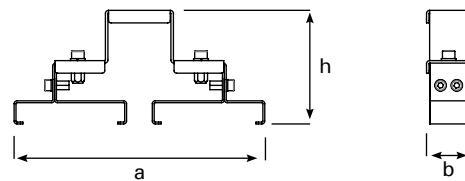

Dimensions (mm)

	a	b	h
Fixed Hanger Set	89	30	63
Angular Hanger Set	90	41	105
Angular Double Hanger Set	200	243	172
Double Hanger Set	199	36	90
Angular Triple Hanger Set	309	250	154

GALIS

-20°C +40°C



- Logistics
- Education and Science
- Complexes
- Shops and Markets
- Office and Administrative Buildings

Maximum performance for extreme conditions

- ✓ High performance waterproof LED luminaire
- ✓ IP66 - IP69 protection & IK09 impact resistance class / Aluminum extruded housing
- ✓ Ambient operation from -20°C to +40°C temperature
- ✓ Standard / mini housing options
- ✓ Flexible mounting with movable mounting spring
- ✓ Quick and easy electrical connection



GALIS Transparent Glass

19 W – 68 W
2432 lm – 9547 lm



GALIS Sanded Glass

19 W – 68 W
1980 lm – 7451 lm



GALIS Mini

10 W – 50 W
1253 lm – 5892 lm
(Transparent Glass)

10 W – 36 W
929 lm – 3924 lm
(Sanded Glass)

Technical Drawing

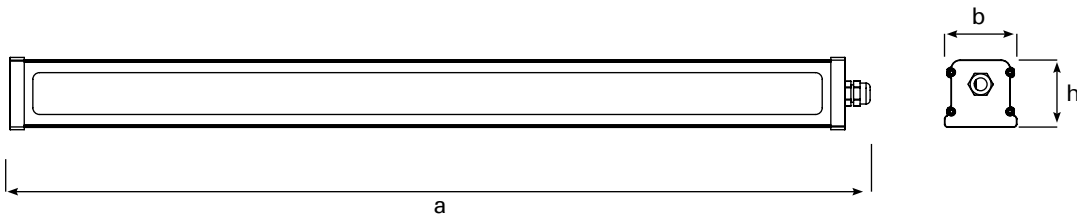

Dimensions (mm)

	a	b	h
Galis	1489	76	70,5

Weight (kg)

Galis	4,4
-------	-----

Fixed Hanger Set

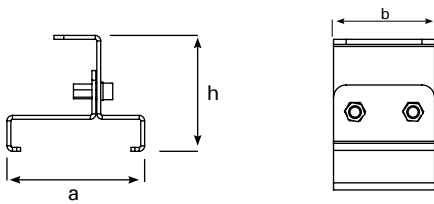

Angular Hanger Set

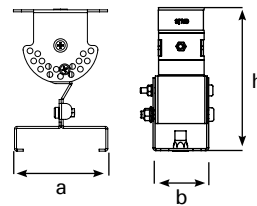

Fixed Supported Mounting Kit

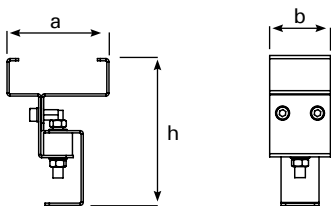

Fixed Hanger Set II

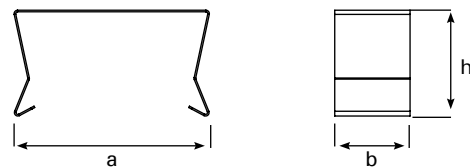

Dimensions (mm)

	a	b	h
Fixed Hanger Set I	71	40	59,4
Angular Hanger Set	69	41	105
Fixed Supported Mounting Kit	71	40	98
Fixed Hanger Set II	58	24	34

YPB BATWING

-20°C +45°C



- Logistics
- Data Centers
- Textile
- Retail and Presentation
- Office and Communication
- Education and Science
- Art & Culture

Solution-oriented, High efficiency lighting

- ✓ Extrusion plastic housing
- ✓ IP65 protection & IK09 impact resistance class / Opal PC diffuser
- ✓ Ambient operating temperature from -20°C to +45°C
- ✓ Different type driver and sensor options for smart lighting / Normal and Through-Wiring options
- ✓ Easy to install and maintain design with advanced features
- ✓ Fewer light lines required with its special optic design for parking garages



YPB BATWING

24 W – 44 W
3407 lm – 6072 lm

Batwing

Technical Drawing

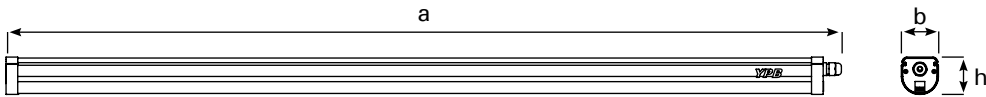

Dimensions (mm)

	a	b	h
Standard	915	57	57

Weight (kg)

Standard	1
----------	---

Fixed Hanger Set

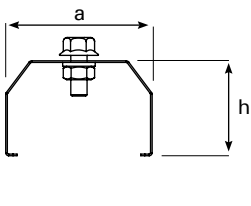

Double Concrete Support Mounting Set

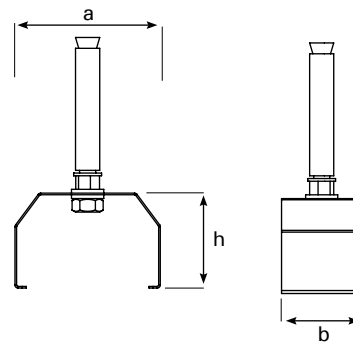

Angular Hanger Set Wall Mounted

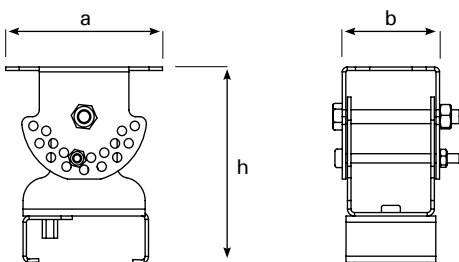

Dimensions (mm)

	a	b	h
Fixed Hanger Set	54	30	35
Double Concrete Support Mounting Set	54	30	35
Angular Hanger Set Wall Mounted	70	41	85

-20°C +40°C



- Logistics
- Machinery and Electronics
- Data Centers
- Technical Rooms
- Canopy Installations
- Multi-storey Car Parks
- Cold Air Storages

Easy installation and connection with custom design

- ✓ High performance LED luminaire
- ✓ IP66 protection & IK07 impact resistance class / Aluminum extrusion housing
- ✓ Ambient operation temperature from -20°C to +40°C
Easy installation and connection
- ✓ Eye-friendly opal diffuser
- ✓ Easy assembly feature
- ✓ Various light angle options
- ✓ Normal and Through-Wiring Options
- ✓ Up to 3 hours emergency kit options / Different type driver options for smart lighting



LINA
NG

25 W – 84 W
2800 lm – 8900 lm

Opal Diffuser

Technical Drawing

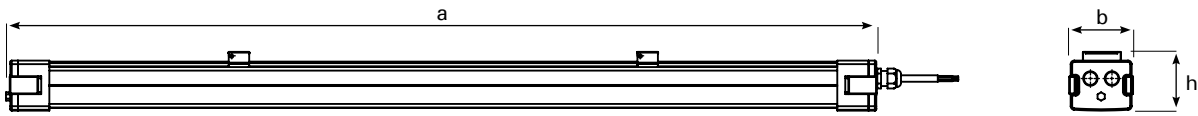

Dimensions (mm)

	a	b	h
120 cm	1200	84,7	69,7
150 cm	1500	84,7	69,7

Weight (kg)

Standard	1
----------	---

Fixed Hanger Set

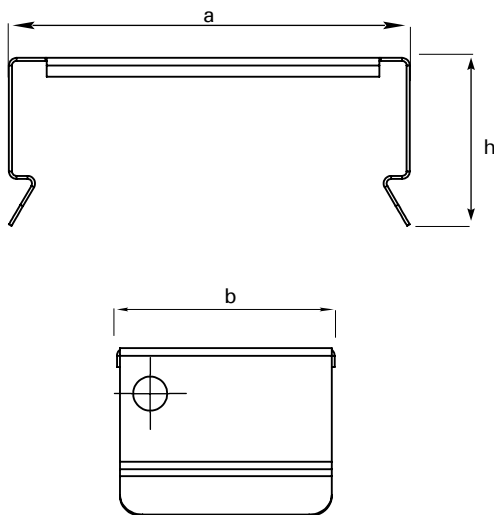

Dimensions (mm)

	a	b	h
Fixed Hanger Set	53	29	22,2
Angular Hanger Set	70	41,2	105,5

Angular Hanger Set

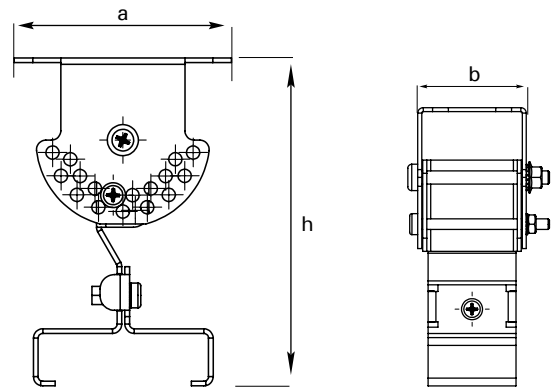

TORNADO

-20°C +35°C



Durable, efficient and comfortable lighting

- Industrial Plants
- Aviation and Airports
- Mixed Buildings
- Logistics
- Metro & Rail Systems
- Sports Halls

- ✓ High protected LED luminaire
- ✓ IP66 protection & IK08 impact resistance class
- ✓ Ambient operating temperature from -20°C to +35°C
- ✓ Up to 3 Hours emergency kit options / DALI Control

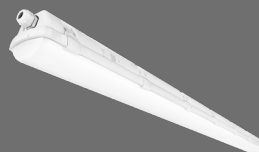

TORNADO

31 W – 80 W
4200 lm - 10400 lm

OPTIC
Opal Diffuser

Technical Drawing

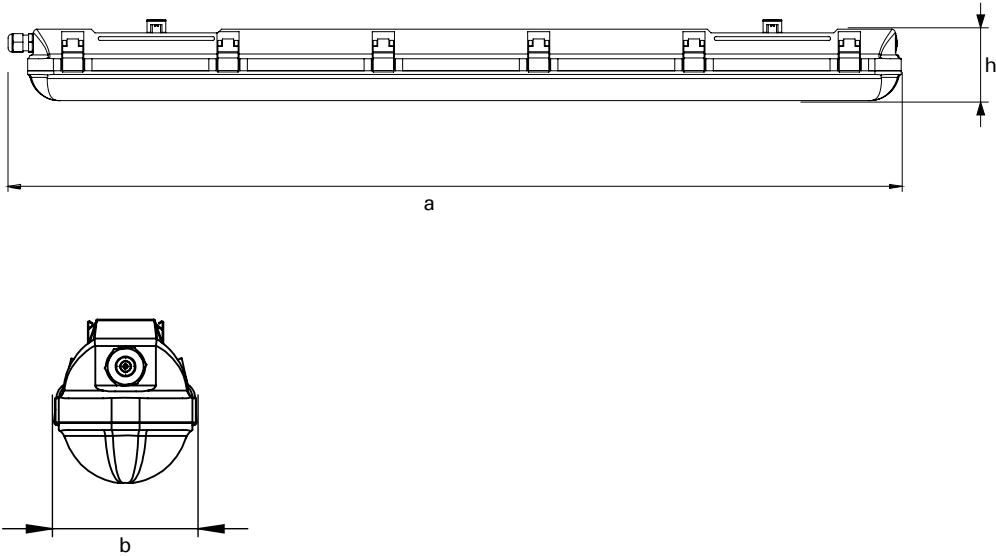

Dimensions (mm)

	a	b	h
Standard	1165	89	85

COZAR

-20°C +40°C



- Industrial Plants
- Aviation and Airports
- Mixed Buildings
- Logistics
- Metro & Rail Systems
- Sports Halls

Economical lighting solution for humid areas

- ✓ IP65 - IP66 protection & IK09 impact resistance class / Plastic extruded housing
- ✓ Ambient operating temperature from -20°C to +40°C
- ✓ Up to 3 Hours emergency kit options / DALI Control
- ✓ Normal and Through-Wiring options
- ✓ Easy assembly feature



COZAR IP65 PLUS

19 W – 75 W
2079 lm – 8347 lm

Opal Diffuser



COZAR IP66

19 W – 75 W
2079 lm – 8347 lm

Opal Diffuser

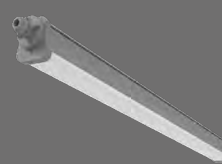

COZAR PLUS BPL

19 W – 75 W
2079 lm – 8347 lm

Opal Diffuser

Technical Drawing

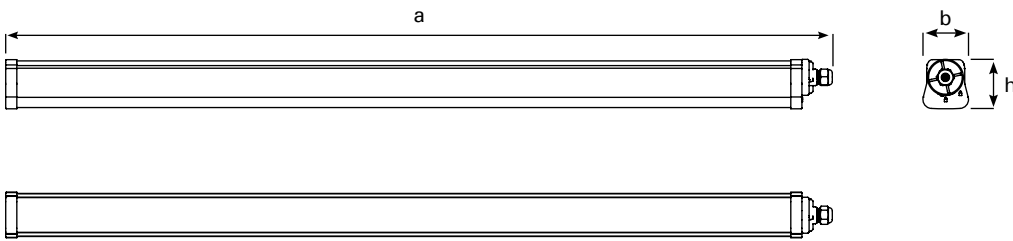

Dimensions (mm)

	a	b	h
545 cm	545	69	75
865 cm	865	69	75
1265 cm	1265	69	75
1505 cm	1505	69	75

Weight (kg)

545 cm	1
865 cm	1,5
1265 cm	1,9
1505 cm	2,2

Angular Hanger Set

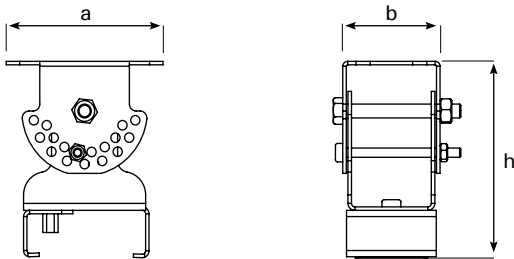

Long Hanger Spring Set

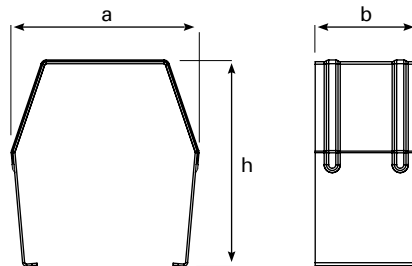

Cable Tray Hanger Set

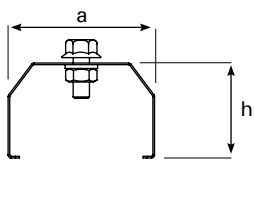

Wall Hanger Set

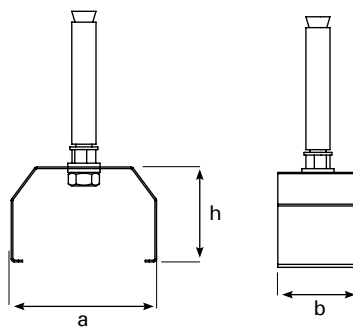

Dimensions (mm)

	a	b	h
Angular Hanger Set	70	41	85
Long Hanger Spring Set	55	30	60
Cable Tray Hanger Set	54	35	30
Wall Hanger Set	54	35	30



- Parking Lot
- Logistics
- Industrial Areas

Great performance output

- ✓ IP66 protection & IK09 impact resistance class / Plastic extruded housing
- ✓ Ambient operation temperature from -20°C to +35°C
- ✓ Eye-friendly opal diffuser
- ✓ Different types of drivers for smart lighting
- ✓ Normal and Through-Wiring options



YPL
NG

30 W – 53 W
3013 lm – 5870 lm

Opal Diffuser

Technical Drawing

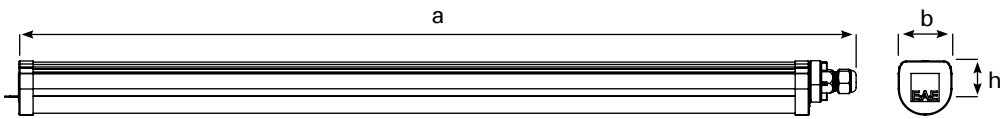

Dimensions (mm)

	a	b	h
85 cm	853	57	57
120 cm	1255	57	57
149 cm	1500	57	57

Weight (kg)

85 cm	0,9
125 cm	1
149 cm	1,3

Fixed Hanger Set

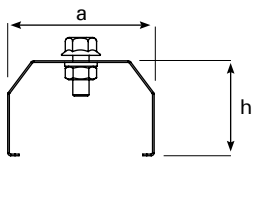

Double Concrete Support Mounting Set

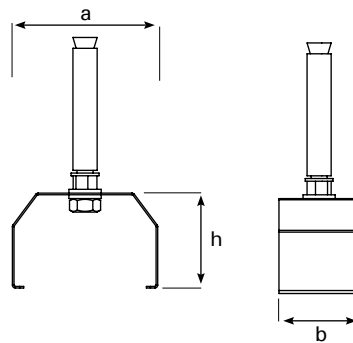

Angular Hanger Set

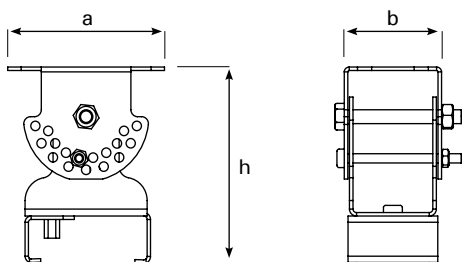

Dimensions (mm)

	a	b	h
Fixed Hanger Set	54	30	35
Double Concrete Support Mounting Set	54	30	35
Angular Hanger Set	70	41	85

GPRONA

-25°C +50°C



- Shipyard
- Ports
- Ship and Shipbuilding
- Aircraft Hangars
- Passenger Ship Facades

The Best Choice of Asymmetric Viewpoint

- ✓ LED luminaire, which is suitable for heavy industrial and port conditions
- ✓ IP66 protection & IK09 impact resistance class / Tempered glass
- ✓ Ambient operation temperature from -25°C to +50°C
- ✓ Perfect solution in the port sites with special asymmetric curve
- ✓ Multi-directional control and automation with DALI, RF, 1-10V and DIMKO options
- ✓ Suitable for special site solutions for special projects
- ✓ High strength against vibrations



GPRONA

135 W – 463 W
21440 lm – 74200 lm

DALI / RF / 1-10V / DIMKO

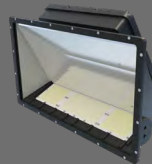

GPRONA PLUS

558 W – 669 W
87538 lm – 102604 lm

DALI / RF / 1-10V / DIMKO

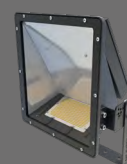

GPRONA MINI

133 W – 185 W
21800 lm – 29400 lm

DALI / RF / 1-10V / DIMKO

Technical Drawing

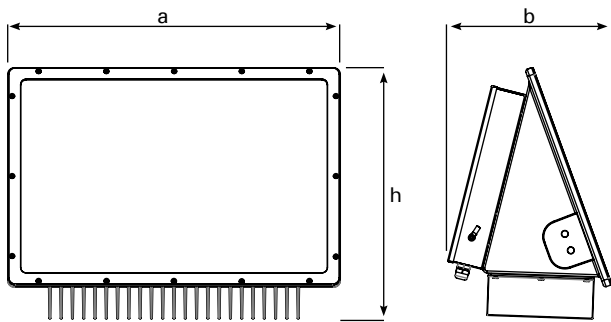

Dimensions (mm)

	a	b	h
Gpron Standard Injection Box	589	296	508
Gpron Standard Luxeon Led	589	317	446
Gpron 10V + RF Injection Box	589	296	529
Gpron 10V + RF Luxeon Led	589	403	446
Gpron DALI + ZHAGA Injection Box	589	296	508
Gpron DALI + ZHAGA Luxeon Led	589	340	446

Weight (kg)

Gpron	22 - 31,5
Gpron Plus	33,5
Gpron Mini	11,8 - 12,3

Dimensions (mm)

	a	b	h
Gpron Plus Standard	698	297	493
Gpron Plus 10V + RF	698	297	513
Gpron Plus DALI + ZHAGA	698	297	492

Dimensions (mm)

	a	b	h
Gpron Mini Standard	374	276	419
Gpron Mini 10V + RF	375	273	483
Gpron Mini DALI + ZHAGA	375	273	445

Angular Hanger Set

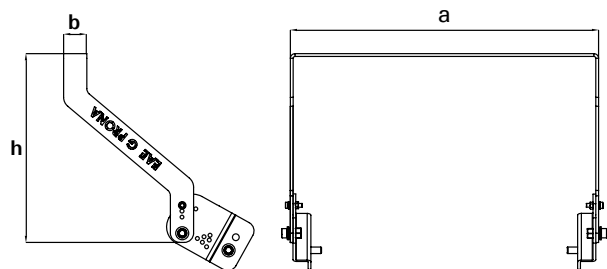

U Type Short Hanger Set

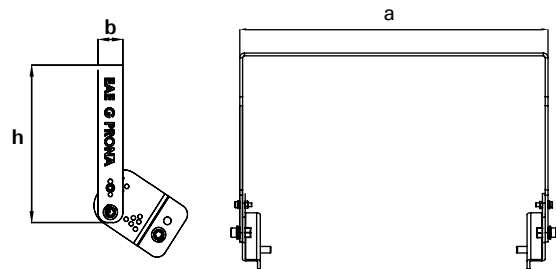

Easy Assembly Hanger Set

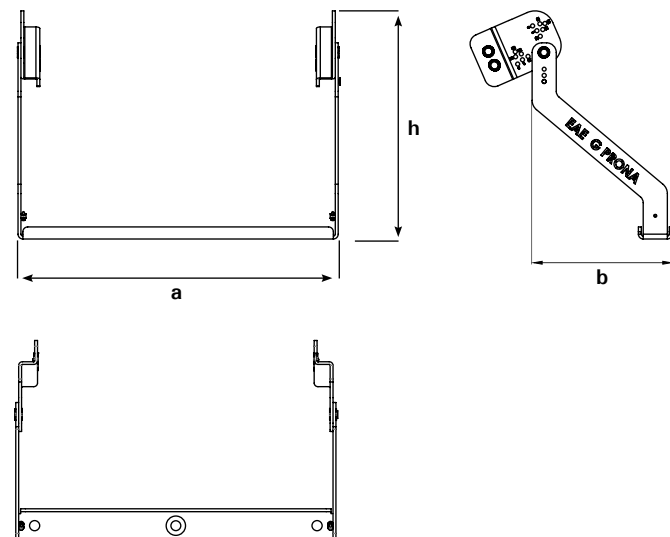

Dimensions (mm)

	a	b	h
Angular Hanger Set	662	50	406
U Type Short Hanger Set	662	50	306
Easy Assembly Hanger Set	662	290	472

SPRONA

-25°C +45°C



- Shipyard
- Ports
- Ship and Shipbuilding
- Aircraft Hangars
- Passenger Ship Facades

Maximum performance for extreme conditions

- ✓ Aluminium housing with high mechanical strength
- ✓ IP66 protection & IK07 impact resistance class / Tempered transparent glass
- ✓ Ambient operating temperature from -25°C to +45°C
- ✓ Optimized, single, dual and triple modular use
- ✓ Functional use in the port and outdoor applications with special Hanger Set

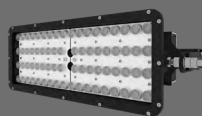

SPRONA

348 W
49527 lm – 51506 lm

OPTIC
20° / 35° / 60°

Technical Drawing

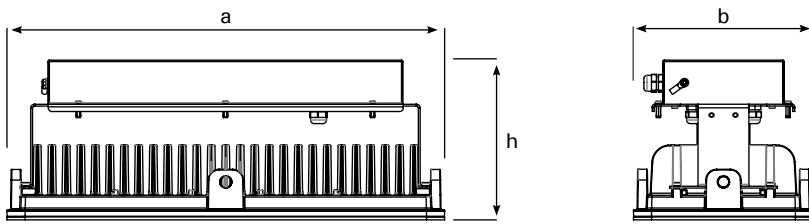

Dimensions (mm)

	a	b	h
Single Module	605	249	220
Double Module	605	615	220
Triple Module	605	980	220

Weight (kg)

Single Module	15,4
Double Module	41
Triple Module	65

Single Hanger Set

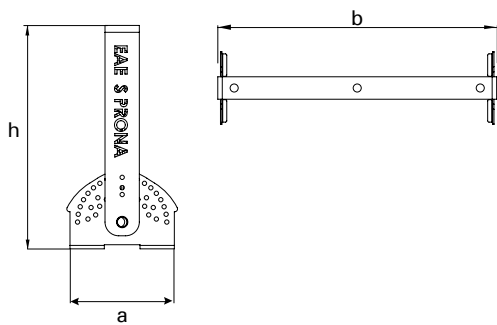

Double Hanger Set

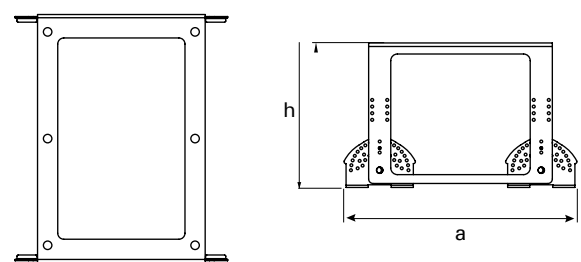

Triple Hanger Set

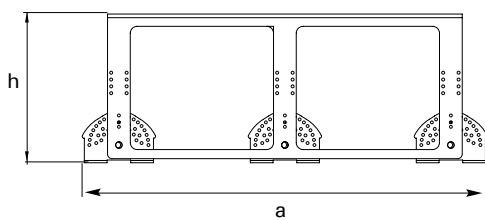

Dimensions (mm)

	a	b	h
Singer Hanger Set	249	616	345
Double Hanger Set	615	-	345
Triple Hanger Set	980	-	345

SPRONA PLUS



- Shipyard
- Ports
- Ship and Shipbuilding
- Aircraft Hangars

-25°C +50°C



Maximum performance in harsh conditions

- ✓ Aluminium housing with high mechanical strength
- ✓ IP66 protection & IK08 impact resistance class / Tempered transparent glass
- ✓ Ambient operating temperature from -25°C to +50°C
- ✓ Functional use in the port and outdoor applications with special hanger set



SPRONA PLUS

851 W – 1051 W
116026 lm – 149147 lm

OPTIC
10° / 22° / 57°

Technical Drawing

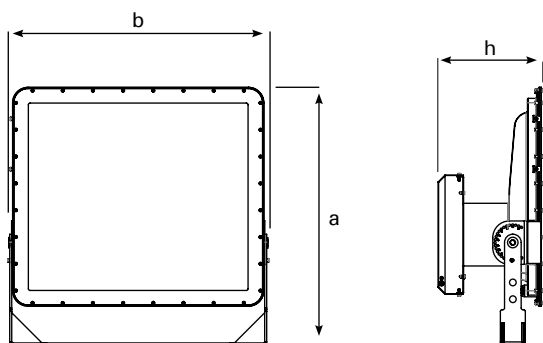

Dimensions (mm)

	a	b	h
Standard	805	768	228

Weight (kg)

Standard	45,8
----------	------

AGILITY



- Shipyard
- Ports
- Ship and Shipbuilding
- Aircraft Hangars
- Passenger Ship Facades

-25°C +40°C



One step ahead in lighting

- ✓ Economic and optimum lighting in outdoor applications.
- ✓ IP66 protection & IK08 impact resistance class
- ✓ Ambient operating temperature from -25°C to +40°C
- ✓ Suitable for football fields, tennis courts, car parks etc.
- ✓ Single, double and triple use alternatives suitable for stadiums
- ✓ Easy installation and maintenance at project sites
- ✓ Optional product as with glass, with sanded glass, and with an extra protective cage without glass



AGILITY Single Modul

62 W – 130 W
7400 lm – 18000 lm



AGILITY Double Modules

257 W
30000 lm



AGILITY Triple Modules

385 W
45000 lm

Technical Drawing | Single Module

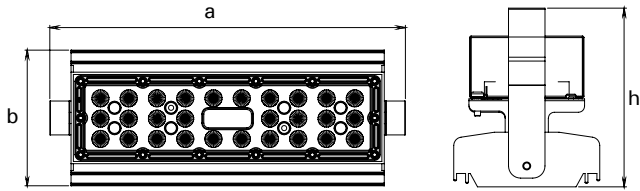

Technical Drawing | Double Module

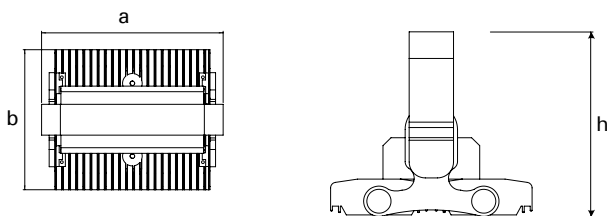

Technical Drawing | Triple Modules

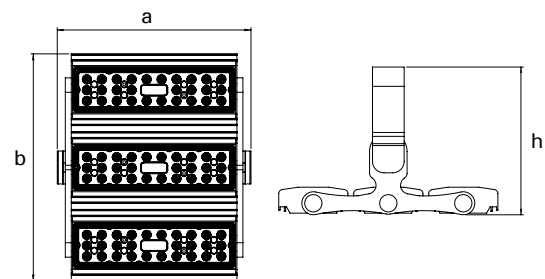

Dimensions (mm)

	a	b	h
Single Module	314	120	147
Double Modules	324	250	232
Triple Modules	324	380	257

Weight (kg)

Single Module	2,8
Double Modules	4,5
Triple Modules	6,7

ALFA (FIVE MODULES)

-20°C +30°C



- Stadium

Push the limits, leave the lighting to Alfa

- ✓ IP66 protection & IK09 impact resistance class / Aluminum injection housing
- ✓ Ambient operating temperature from -20°C to +30°C
- ✓ Optionally available up to 5 modules
- ✓ Ideal lighting with optimized technical features. for sports areas
- ✓ High efficiency value and advanced optical design
- ✓ Special LED and CRI options for TV shooting



ALFA Two Modules

589 W
59155 lm / 69000

ALFA Three Modules

884 W
88733 lm / 103600 lm

ALFA Four Modules

1112 W / 1207 W
113000 lm / 118835 lm

ALFA Five Modules

1392 W / 1475 W
141256 lm / 147888 lm

Technical Drawing

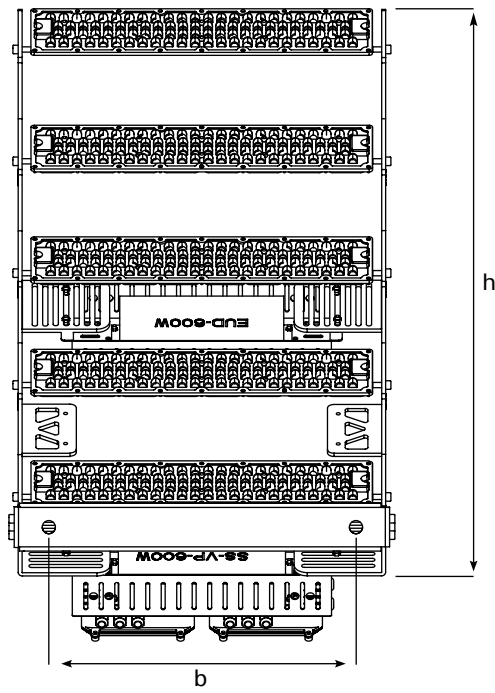

Technical Drawing

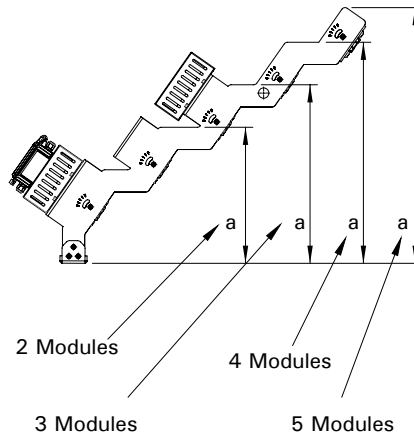
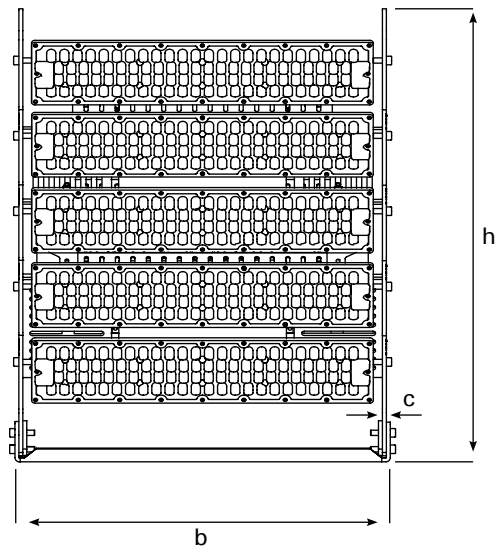

Dimensions (mm)

	a	b	h
Two Modules	572	649	404
Three Modules	572	649	404
Four Modules	572	649	404
Five Modules	572	649	508

KANOLED

-30°C +50°C



LED Luminaire for Fuel Stations

- ✓ Excellent performance for flammable and combustible areas
- ✓ IP65 - IP66 protection & IK07 impact resistance class
- ✓ Ambient operating temperature from -30°C to +50°C
- ✓ One-to-one exchange up 250W HIT

- Oil Refineries
- Tanker Filling and Unloading Areas



KANOLED V.3 IP65

46 W – 133 W
6600 lm - 15310 lm

Tempered Glass - Glazed Glass

OPTIC
Wide Angle / 115°

Wiring Option



KANOLED V.3 HE

60 W – 100 W
9700 lm - 14415 lm

Transparent Glass

Technical Drawing

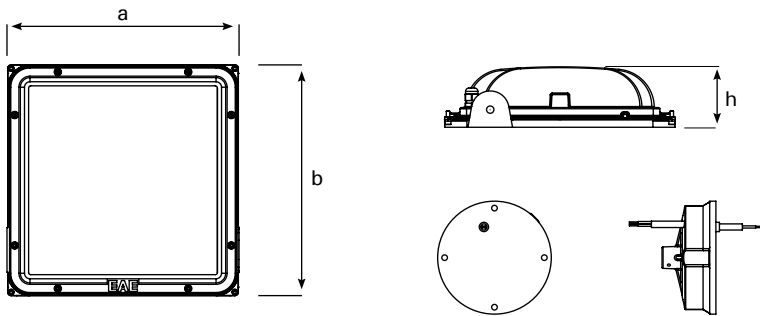

Dimensions (mm)

	a	b	h
Standard	336	336	89

Weight (kg)

Standard	5
----------	---

External EMG Kit Box Standard

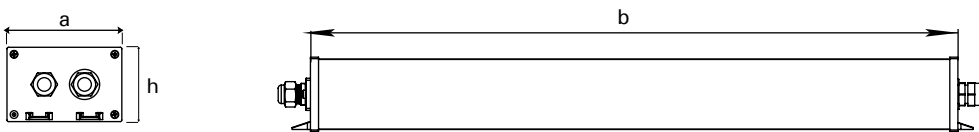

External EMG Kit Box DALI

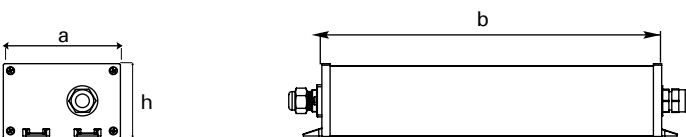

U Hanger Set

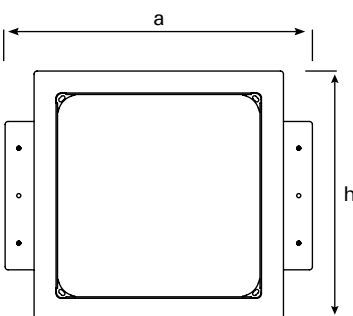

Dimensions (mm)

	a	b	h
External ACK Box	114	673	74
External ACK Box DALI	114	363	74
Metal Hanger Set	517,5	92,5	420



Meet Sustainable Energy Saving!

Dimko is used as a signal generator in light control devices, dimmer/increase control of time relays. The module is an EAE Lighting control solution that allows the user to adjust the time and lighting level.



DIMKO SCENARIO

System opening and closing hours can be set with 7 different scenarios according to summer and winter months.

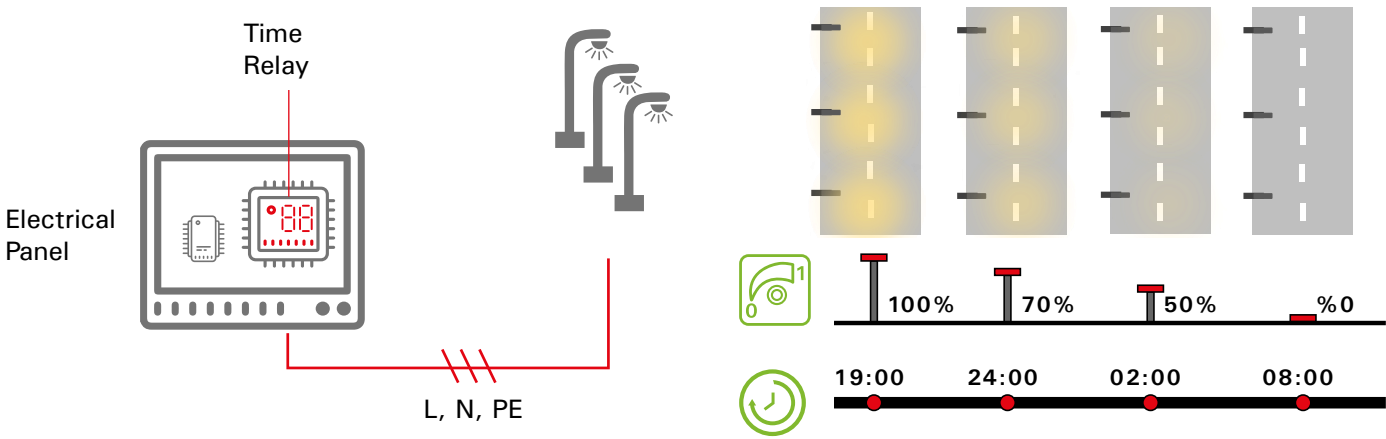

Products compatible with DIMKO



RA

RA 2

RA 3

ARKTOS

DIMKO



Quick, easy and affordable...

%81
Energy savings up to **81%**.



Dimming system that does not harm the ecosystem.





No maintenance costs.

%55
ABOVE
Savings of more than **55%** on lighting expenses.

Advantageous installation
Installation without expensive duct excavations.

Efficient time management.
It can be programmed within 40 seconds.

Possibility of use with existing infrastructure
No need to replace existing luminaires and poles.

Simple control
Provides control without the need for a team of experts.



PROLIT



PROLIT PLUS



PROLIT KOMPAKT



**PROLIT-M PRM
V.2**

SL / DL BUSBAR

E-Line SL/DL Busbar Distribution Systems are used in building electrical installations with a power requirement of 25 to 40A. 16A output sockets and 25A output boxes are designed to supply lighting and wall socket circuit as per their specifications.

EAE Busbar Systems are produced in accordance with ISO 9001 standards with a certified Quality Assurance System using the world's latest manufacturing technologies. Units are designed and tested according to IEC 61439-6.



Tap-off Plugs
Tap-off plugs for SL / DL Busbar systems are designed with different contact arrangements. All the plugs are produced in order to be connected to the busbar in one direction to prevent the use of a wrong phase.

Safety
Earth contacts of the tap-off plugs make first when plugging-in, and the contact breaks last when unplugging.

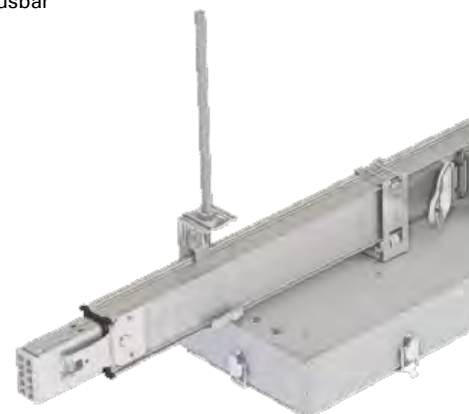

Colour Coded Covers
Indicate The Phases

The covers of the tap-off plugs are designed with different colours to indicate which phase the light fittings are fed from.



ELINESL

(Only one side has conductor)

4 Plug-in Points are provided on a Standard 3m Length
A total of 4 plug-in points on single side are provided as standard.

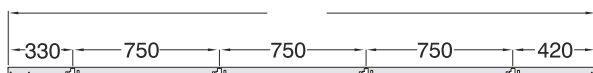
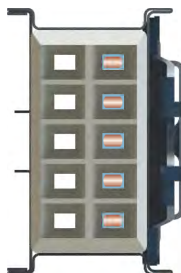

ELINEDL

(Both sides have conductor)

8 Plug-in Points are provided on a Standard 3m Length
A total of 8 plug-in points (4 on each side) are provided as standard.

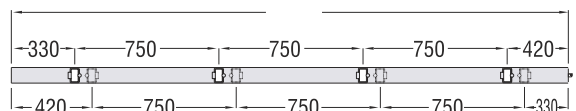
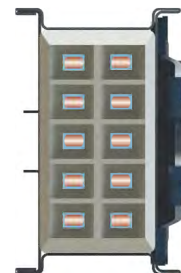



Full Isolation

The busbar conductors are coated in flame-proof insulation material. Total security regarding human safety is provided even when the housing is severely damaged due to external heavy impacts that may occur.



Fast, Easy and Secure Assembly

Achieved with single action by driving the mechanical and electrical joint silver coated sprung contacts towards each other. The joint is secured by tightening one screw. It is not necessary to install the joint cover to secure the joint.



Tin Coated Conductors

Formation of Copper Oxide is prevented by tin plating the conductors along their full length. This ensures that contact resistances are minimised. The contacts of the tap-off plugs contact the busbar conductors on two surfaces.

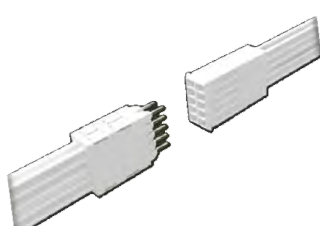

Silver Coated Joint Contacts

The contacts at the joints of the busbar and the contacts of all tap-off units are silver coated. The silver coating minimises the contact impedances, thus preventing the over-heating of the contacts in case of possible over-loads.



EAE LIGHTING INC.
İkitelli OSB Mah. Eski Turgut Özal Cad.
EAE No: 20, İç Kapı No: Giriş Kat
Başakşehir / İSTANBUL - TÜRKİYE
Tel : +90 212 413 21 00 (pbx)
Faks : +90 212 549 37 90
www.eaelighting.com

engineering the light

EAE LIGHTING-Brochure **AGU JETRIAL LIGHTING PRODUCT HIGHLIGHTS 2023 - EN** - Update Date: 02.11.2023
EAE. is provided with the right to perform changes deemed necessary without notifying in advance.
Please contact us for further information about products and details partaking in catalogue.